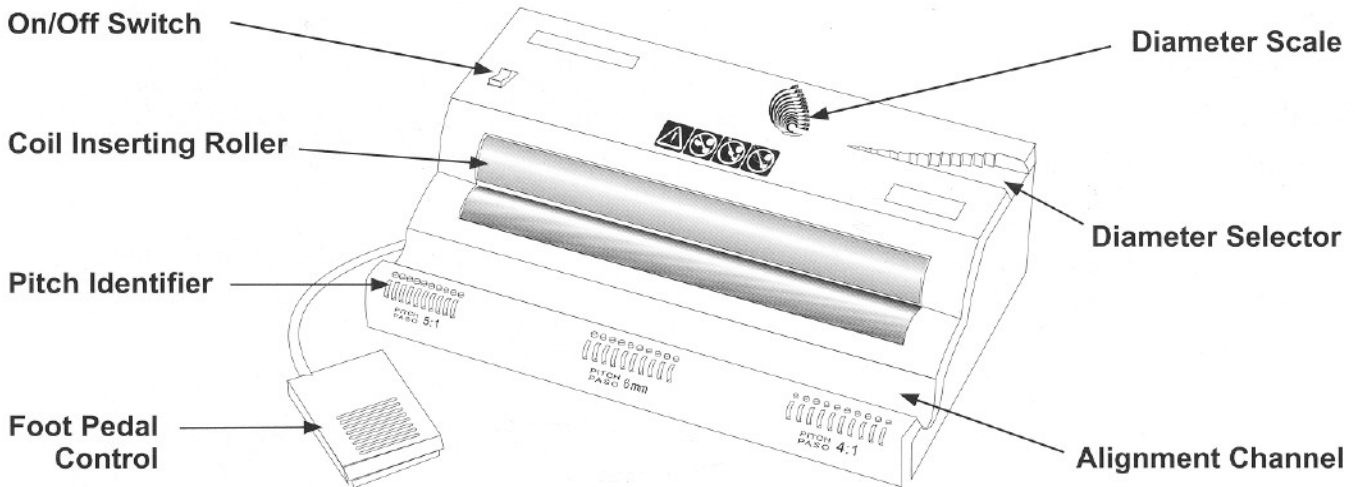

INTRODUCTION

CONGRATULATIONS ON THE PURCHASE OF YOUR NEW **Roll-@-Coil**. A PROFESSIONAL AND EFFICIENT COIL BINDING MACHINE. YOUR **Roll-@-Coil** WAS CAREFULLY DESIGNED WITH A FULL RANGE OF FUNCTIONS AND PREMIUM QUALITY COMPONENTS TO GUARANTEE AN EFFORTLESS AND PROFESSIONAL BIND, AS WELL AS MANY YEARS OF TROUBLE-FREE SERVICE.

IMPORTANT

WE RECOMMEND THAT YOU TAKE A FEW MINUTES TO FAMILIARIZE YOURSELF WITH THE FUNCTIONS OF YOUR NEW **Roll-@-Coil**. YOU WILL FIND THAT WITH JUST A LITTLE PRACTICE, ANYONE CAN ACHIEVE PROFESSIONAL RESULTS.

FEATURES**ASSEMBLY**

1. Place your new **Roll-@-Coil** on top of a sturdy working table. **See picture 1**
2. Turn on switch and press foot pedal to test inserting roller. **See picture 2.**

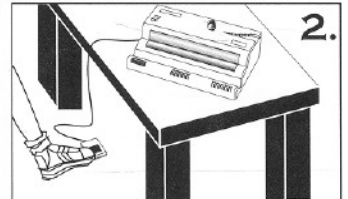
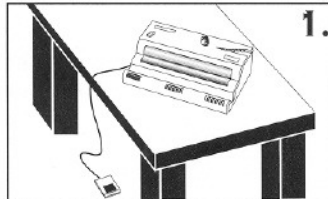
**SAFETY INSTRUCTIONS**

1. Keep fingers, hair, jewelry, necktie and any loose clothing or objects away from roller, as they may be accidentally pulled into the roller.
2. Do not allow children to operate the machine. The **Roll-@-Coil** is not a toy.
3. Always turn switch-off and place foot pedal out of reach when machine is not in use.
4. To reduce the risk of electric shock, never operate the **Roll-@-Coil** near water.
5. Do not use the **Roll-@-Coil** if power cord is damaged.
6. Do not allow the electric cord to be in contact with hot surfaces.
7. In case of malfunction, return the unit to your distributor for service. This equipment does not contain any part that can be serviced by the consumer or operator.



PRE-INSERTION

OPTIONAL STEPS:

1. Use Pitch Identifier function to verify that the coil pitch matches that of the punched document. See Picture 1.
2. Place to-be-bound document into Coil Diameter Selector to best select the correct coil diameter size.
3. Align coil diameter to Diameter Scale, to verify that the coil size is what you require. See Picture 2.

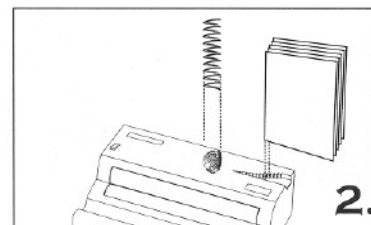
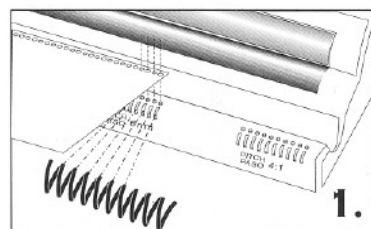

COIL INSERTING (BINDING)

1. Align punched document on Alignment Channel. This feature is especially helpful for larger documents. See Picture 1
2. Place document on top of machine or table and insert the coil into the first 4 to 5 holes. See picture 2
3. Hold document evenly against roller (coil must slightly touch the roller). See picture 3
4. Press foot pedal. The coil will automatically move forward inserting itself into the holes. See picture 3
5. After the last hole insertion, IMMEDIATELY move document away from roller and/or stop pressing the foot pedal. Remark: if coil is over inserted or some pages are un-inserted, simply flip document over and proceed with insertion as per step 3.
5. Use crimpers to cut & crimp the excess coil. Make sure you crimp-in both ends. This procedure will prevent the document from unbinding itself. See picture 4

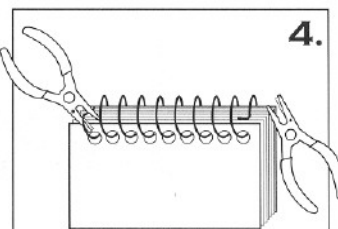
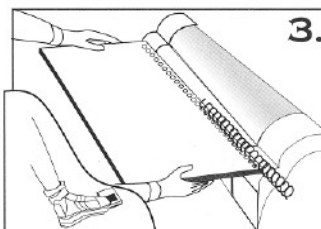
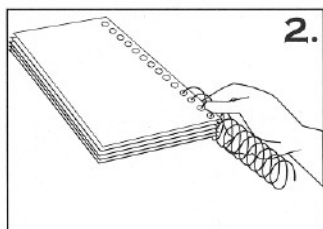
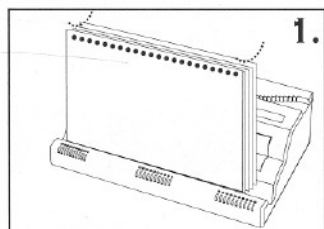

WARRANTY POLICY

YOUR **Roll-@-Coil** HAS A WARRANTY OF ONE YEAR FROM DATE OF PURCHASE. IN THE EVENT OF A MANUFACTURER'S DEFECT, YOUR DISTRIBUTOR (AT OPTION) WILL REPAIR OR REPLACE IT. IMPORTANT: THIS WARRANTY DOES NOT COVER DAMAGES DUE TO IMPROPER USE OR MISS TREATMENT OF THE UNIT, INCLUDING ANY EXTRAORDINARY EVENT LEADING TO THE DAMAGE OF THE MACHINE, WHETHER IT IS REVERSIBLE OR NOT.

IF THE **Roll-@-Coil** IS NOT WORKING PROPERLY, FIRST FOLLOW THE CORRECTIVE ACTIONS ABOVE. IF THE PROBLEM PERSISTS, PLEASE CONTACT YOUR DEALER FOR FURTHER INSTRUCTIONS. PLEASE HAVE YOUR MACHINE'S SERIAL NUMBER AND THE PURCHASE DATE READY. IF THE MACHINE MUST BE RETURNED TO YOUR DISTRIBUTOR, IT IS YOUR RESPONSIBILITY TO PROPERLY PACK AND SHIP IT. AS ANY DAMAGES INCURRED DURING ITS TRANSPORTATION IS NOT COVERED BY OUR WARRANTY POLICY.