

Operation Manual



Dry-Lam Element Series



Standard, Deluxe and Professional 27” Roll Laminators

DO NOT DISCARD BOX AND/OR ORIGINAL PACKAGING!!!

IF, FOR ANY REASON, YOU NEED TO SHIP YOUR MACHINE BACK AND YOU DISCARD THE ORIGINAL PACKAGING, YOU WILL BE RESPONSIBLE FOR PURCHASING ANOTHER BOX AND THE FREIGHT TO SHIP THE BOX TO YOU.

PLEASE READ THESE INSTRUCTIONS PRIOR TO OPERATING THE LAMINATOR. FAILURE TO LOAD FILM CORRECTLY WILL VOID ALL WARRANTIES.

TABLE OF CONTENTS

Introduction	3
Laminator Features.....	3
Important Safety Instructions & Important Safeguards	3-5
Initial Set-up	5-9
Components.....	5-7
Heat Control.....	8
Set Temperature.....	8-9
Operation	9-12
Loading Laminating Film.....	9
Threading Laminating Film.....	10-11
Adjusting Mandrel/Film Tension.....	12
Laminating	12
Mounting and Laminating	13
Safety Features	13
Trouble Shooting	14-15
Maintenance	15-16
Cleaning Rollers.....	15
Removing Wrap-arounds.....	16
Warranty & Return Policy	17

INTRODUCTION

Thank you for choosing the Element Series Roll Laminator by Dry-Lam. Our goal is to produce quality, user-friendly laminating machines with features that enable you to easily create excellent results with each use. Before using the machine for the first time, please take a few minutes to read this user manual. We hope this enables you to achieve a perfect lamination every time.

The Standard Model will accept rolls of laminating film up to 27" wide and up to 3 mil in thickness.

The Deluxe Model will accept rolls of laminating film up to 27" wide and up to 5 mil in thickness.

The Standard Model will accept rolls of laminating film up to 27" wide and up to 10 mil in thickness.

IMPORTANT SAFETY INSTRUCTIONS

This safety alert symbol precedes any safety message in this manual. This symbol indicates a potential safety hazard that could hurt you or others, as well as result in product and/or property damage. Please read carefully.

Do not attempt to service or otherwise repair this laminator. Please have it serviced by a qualified service professional.

Do not connect the laminator to an electrical supply or attempt to operate the laminator until you have completely read these instructions.

Running the machine in reverse when there is film on the front rollers, especially hot film can cause a wrap-around. This can cause the film to displace the temperature sensor away from the roller causing the heat controller to receive and display an incorrect reading. This may result in overheating of the rollers and possibly damage.



Before reversing the machine to remove a wrap-around, cut the film from the supply roll and pull the film away from the front rollers.



To avoid any damage, please do not use razors or sharp objects near the rollers.



It is best to not leave machine on when not in use or turn the heat down to prolong the life of the rollers and avoid damage.

IMPORTANT SAFEGAURDS

For your protection, do not connect the laminator to electrical power or attempt to operate it until you read these instructions completely. Keep these instructions in a convenient location for future reference. This instruction manual and labels affixed to the laminator are important safety messages. Read these messages carefully.

- Use this laminator only for its intended purposes as according to the specifications outlined in this instruction manual.
- Keep hands, long hair, loose clothing and articles such as ties and necklaces away from the pull rollers.
- Avoid contact with heated rollers during operation and shortly after operations as heated rollers can reach temperatures in excess of 300°F and can cause burns. Allow the rollers to cool before touching.
- Place laminator on a sturdy cart, stand, or table. A laminator placed on an unstable surface may fall, causing serious bodily injury. Move laminator with caution. Quick stops, excessive force, or uneven floor surfaces may cause the laminator and cart to overturn.
- Unplug laminator before moving, or when not in use for an extended period of time.
- Never override or attempt to defeat electrical or mechanical interlock devices.
- Never insert objects or spill liquids in or on the laminator. They may contact dangerous voltage points or short out components that could result in fire or electrical shock.
- Do not overload electrical outlets as this can potentially lead to fire or shock.
- The laminator should only be operated from the type of power source indicated in these Operating Instructions and on the data plate located on the rear panel of the laminator.
- The three-pronged grounding plug is a safety feature and will only fit into a grounding-type power outlet. If you are unable to insert the plug into an outlet, contact a qualified electrician to have a suitable outlet installed.
- Do not leave the laminator power on overnight. Unplug the laminator at the end of the day.
- Unplug the laminator before moving it or when it is not in use for an extended period of time as a precaution against the possibility of an internal malfunction that could create a fire hazard.
- Never attempt to open or otherwise repair the machine. Unplug the laminator from the electrical outlet and contact an authorized service representative under any of the following conditions:
 - The power supply cord or plug is damaged or frayed.
 - If liquid has been spilled into the laminator or it has been exposed to water.
 - If the laminator has been subjected to excessive jarring through being dropped or bumped.
 - If the laminator does not operate normally when following the operating instructions.

IMPORTANT SAFEGUARDS (Continued)

- Do not operate the laminator with a damaged power supply cord or plug, or after it malfunctions or has been damaged in any manner.
- Keep the power cord away from hot or wet surfaces
- Do not overload electrical outlets beyond their capacity as this can result in fire or electrical shock. **This unit is rated at 15A and should be the only item plugged into a 15A.** When connected to a 20A branch, any items in addition to the Laminator must not exceed 4A.
- Adjust only those controls that are specified in these Operating Instructions.

INITIAL SETUP

Unpacking and Assembly...

- Inspect shipping container and unit for signs of damage. Notify carrier and dealer *immediately* should any damage be noted.
- ***Retain packaging in case you need to return the machine for repair.***
- **This machine is big and bulky. Use two people when removing the machine from the shipping container.**
- Place the laminator on a flat and stable surface that is capable of supporting the weight of the machine.
- Position the laminator so as to allow film exiting the machine to drop freely to the floor.
- Connect power cord to an appropriate power source.



Components...

The figures below show the location of the major components and controls on the Element Series laminators. You should become familiar with the components and controls of your Dry-Lam model prior to operating the unit.

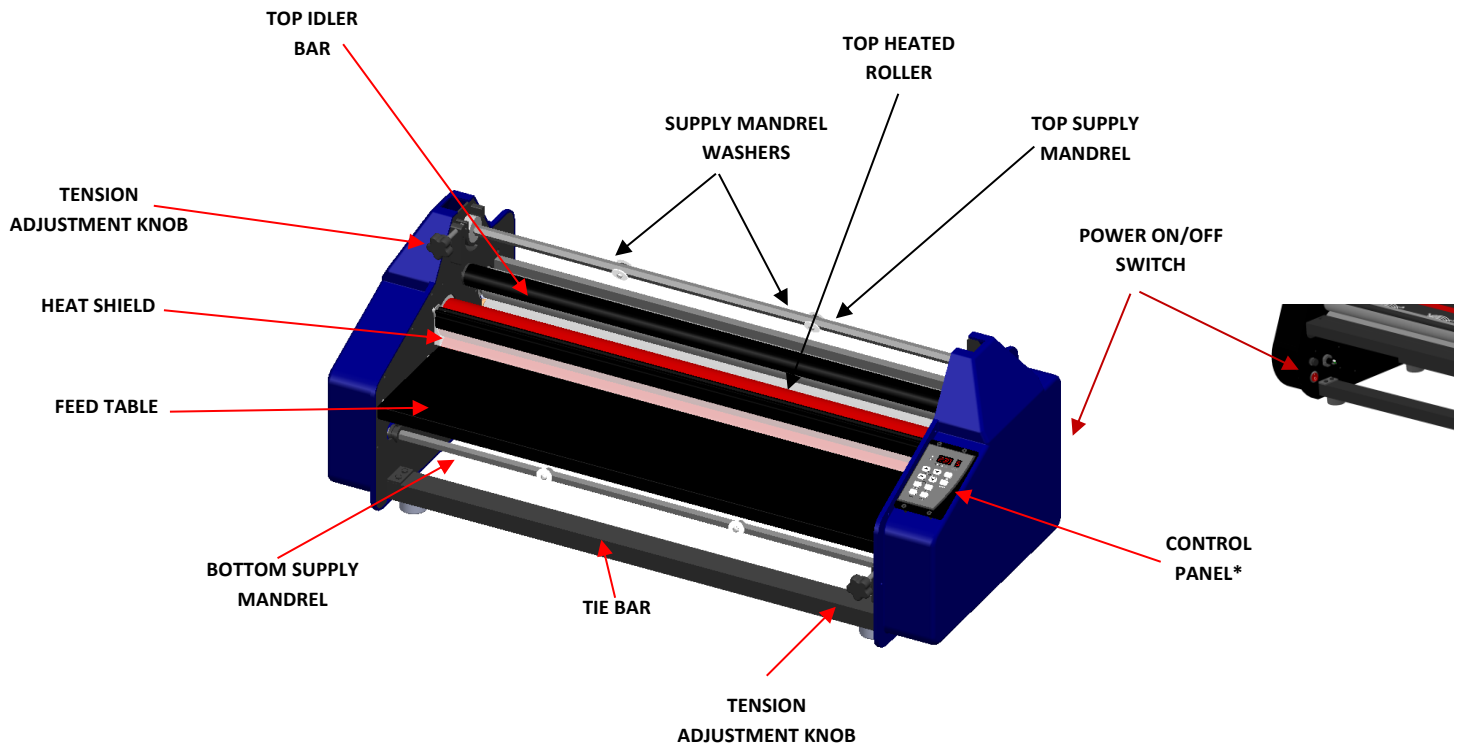

Heat Shield: Protects against accidental contact with heated rollers

Feed Table: Surface used to position documents to be laminated

Supply Mandrels: Metal rods that hold film supply rolls in place; two rolls of laminating film with the same width must be present while laminating; failing to do so will result in damage to the machine

Supply Mandrel Washers: Ensures that film is securely in place on the supply mandrel

Heated Rollers: Silicon rubber coated steel rollers that simultaneously compress and heat the adhesive of laminating film onto the document as it passes through the laminator.

Pull Rollers: Located at the rear of the laminator; these rollers pull the laminated document through the laminator.

Tension Adjustment Knobs: Screws located near the supply roll that when tightened increase tension.

Rubber Foot: Provides nonslip grip for laminator

Idler Bars: Located close to supply rolls; used to direct film to heated rollers

Rear Horizontal Trimmer: Used to trim lamination after it exits the rear of the laminator; trimmer contains a sharp blade and must be used with caution; only on PLUS and PRO models

Power On/Off Switch: Located in the rear of the machine; flip switch to "ON" position to power on laminator

Control Panel: Control panel options may vary depending on the model of the laminator; see figures below for the control panel on your particular model

Control Panel

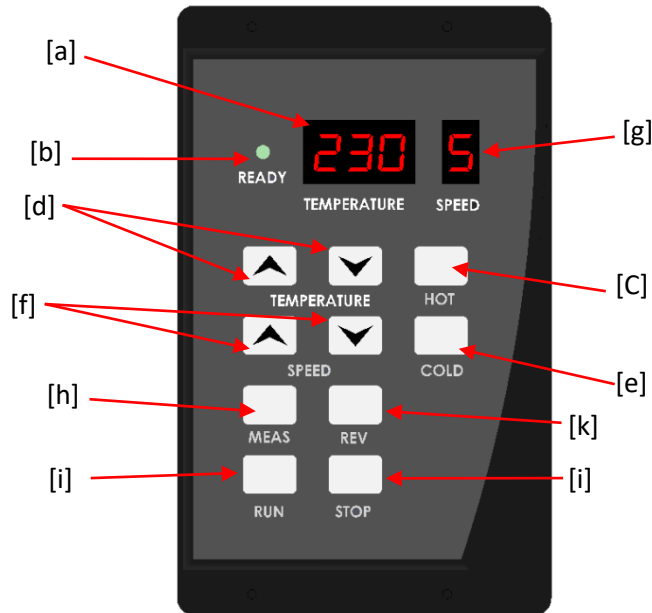

[a] **Temperature Readout** – displays set temperature of the laminator

[b] **Ready Indicator Light** – LED light would come on and remains completely illuminated when the machine has reached the set laminating temperature.

[c] **Hot Button** – When pressed, the front top & bottom rollers’ temperature are set by default to 230F.

[d] **Temperature Control Buttons** – press the ▲ to increase the temperature; press ▼ to decrease the temperature.

[e] **Cold Button** – When pressed or when machine is powered up, the “Cold” button would be set by default to 32F.

[f] **Speed Readout** – By default, when the machine is powered up the display shows speed “5”.

[g] **Speed Control Buttons** – press the ▲ to increase the speed; press ▼ to decrease the speed; only on the PRO model.

[h] **Measure Button** – when pressed and held down, the temperature display shows the ACTUAL temperature of the machine at that given moment.

[i] **Run Button** – when pressed, initiates roller movement

[j] **Stop Button** – when pressed, stops the movement of the rollers.

[k] **Reverse Button** – must be when pressed and held on speed 5 or more, moves rollers in the reverse direction; ensure the rollers have been stopped using the Stop Button prior to using the reverse button; to use, press and hold to reverse roller direction; useful clearing wrap-arounds and for clearing film from

the rollers. [Note: DO NOT RUN THE ROLLERS IN REVERSE WHEN THERE IS FILM ON THE FRONT ROLLERS.]

Heat Control...

Your new Element Series Laminator has a digital heat controller. Users can easily adjust the set temperature for the heated rollers to achieve the best quality lamination. The controller has been calibrated to accurately display the roller temperature in the laminating range.

The laminating temperature should be adjusted according to the film thickness and the item being laminated. See Table 1 below for recommended temperature settings. Keep in mind that the temperatures listed in the table below are approximate, and different brands of laminating film may require different temperatures. Always set your machines temperature according to the film manufacturers' recommendation.

When power is being sent to the heaters, the green ready light indicator will come on 10F degrees earlier before set temperature, this is normal, and the unit will be ready to run application thru. Power to the heaters will cycle when the roller temperature falls below the set temperature during laminating or while sitting idle. Temperature fluctuation is normal. *[Note: As items pass through the laminator, heat is transferred from the rollers to the laminated document causing fluctuations in temperature. These fluctuations will cause the indicator light the flash as the machine requires more heat to reach the set temperature.]*

Set Temperature...

Each time the machine is turned on it will by default go to "COLD" setting and displays a temperature of 32°F. Press the "HOT" button which will turn the machines heaters on and begin to heat to the preset temperature of 230°F. To change the set temperature, use the temperature control buttons to increase and decrease the temperature; press the "▲" to increase the temperature; press "▼" to decrease the temperature. The digits will change slowly initially but will increase speed when held down longer for large changes. When the desired setting has been reached, release the button. *[To determine the actual roller temperature at any given time, simply hold down the "MEAS" button, and the temperature readout will display the current roller temperature.]*

Important Notes:

Overheat Display "O-H": the temperature readout display may show an abbreviation for overheat momentarily should the rollers' surface temperature becomes too hot (above 305F degrees) when temperature is set above 275F & above. This is normal and it usually happens during the last phase of initial warm up time but will eventually drop down and the display will show the set temperature again.

Auto shut off "pof": certain models feature an auto shut off option and it will cut off power to the heaters if the machine is set idle for more than two hours. To regain power, the "RUN" must be pressed, and the readout display will show the set temperature again.

The following chart has recommended temperature and speed settings using standard laminating film. Please check the specifications on your film for proper melting temperatures.

Table 1

Material	Temperature Range	Speed
1.5 mil (.0015") (standard LDPE/school film)	265°F - 275°F	2-5
3 mil (.003") (standard LDPE/school film)	265°F - 275°F	2-5
3 mil (.003") (low melt EVA film)	260°F - 270°F	2-5
5mil (.005") (low melt EVA film)	250°F - 260°F	2-3
10mil (.010") (low melt EVA film)	260°F - 270°F	1-2

OPERATION

This section describes the operation of the laminator. This laminating is designed for all widths of laminating film up to 27". However, if narrower widths are used, the rollers must be cleaned before using a wider roll. Refer to the Maintenance section for cleaning instructions.

Prior to using your laminator, ensure that the POWER ON/OFF SWITCH located in the rear of the machine is switched to the 'ON' position.

Loading Laminating Film onto Mandrels...

Slide the film onto the mandrel. Make sure the film is pushed all the over the supply mandrel washers; this will ensure that the film will not shift during laminating. Remove the film in the same direction. Do not to twist the roll of film or the empty core when removing them from the mandrel.

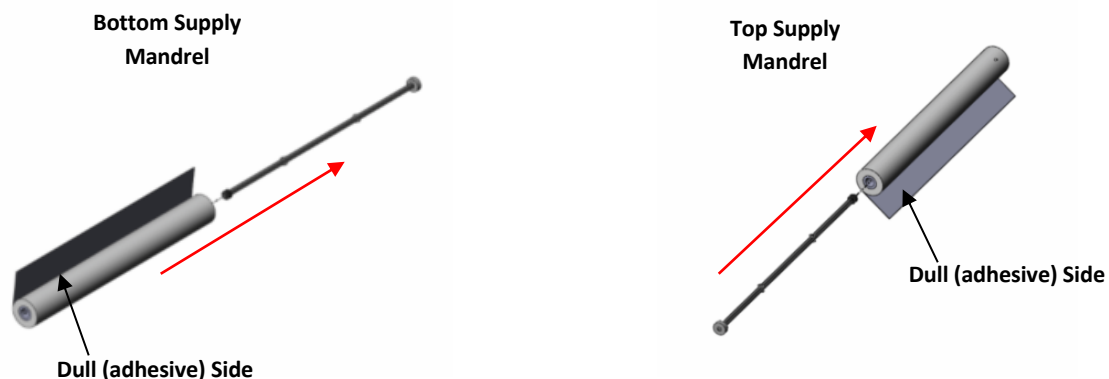

Threading Laminating Film...

These instructions apply to poly-in film rolls (shiny side out, dull side in)

1. For the top supply roll place the mandrel ends into the slots in the top of the laminator. If you are facing the front of the laminator the film should unwind toward you from the bottom of the roll as in Figure 3 on the next page.

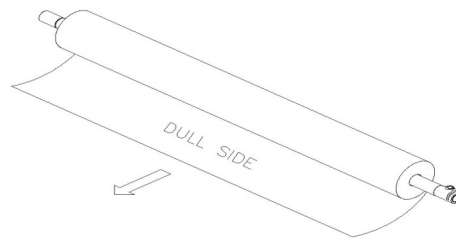

Figure 3

2. Pull 6"-12" of film from the top roll. Pass the film under the idler bar and over the roller. Make sure the shiny side of the film is against the roller.

3. For the bottom supply roll, remove the feed table. Place the mandrel ends into position in the lower mandrel holder slots. Return the feed table to its proper position before operating the laminator. If you are at the front of the laminator the film should unwind away from you at the bottom of the roll as in Figure 4 below.

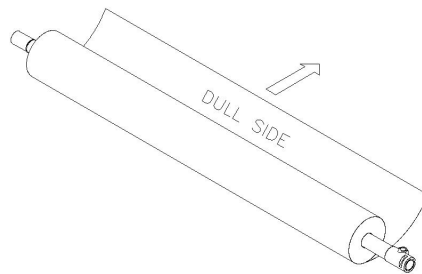

Figure 4

4. Pull 6"-12" of film from the bottom roll. Pass it under the lower idler bar and drape the film from the bottom roll over the film from the top roll. Since the rollers are hot the bottom film will adhere to the top film. See Figure 5 below.

Note: The shiny side of the film must always go against the rollers.



The rollers reach a temperature of up to 300°F. Do not touch the surface of the heated rollers.

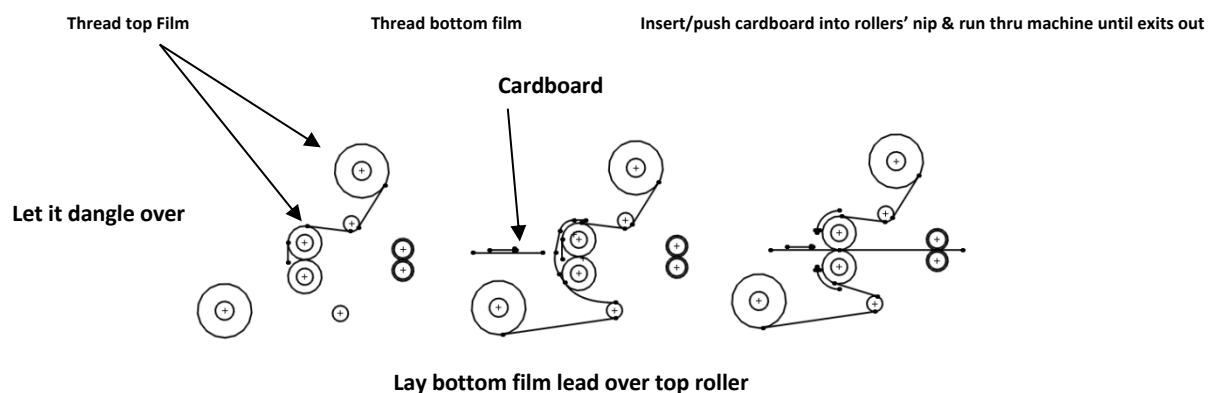
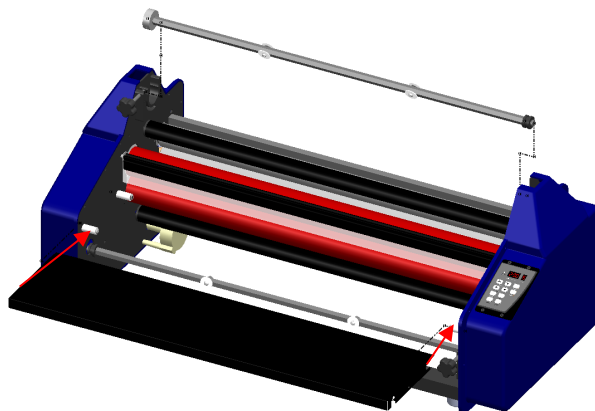

Figure 5

5. Press the "Run" button to start the Laminating and Pull Rollers.
6. Feed a piece of thin cardboard about 10" x 25" against the film so that it is centered between the two rollers. Push the cardboard and film into the Laminating Rollers. See figure 5.
7. When the feed card has completely exited the Pull Rollers at the rear of the laminator, press the "Stop" button to stop the rollers.
8. Insert the Feed Table onto the studs located on each side of the unit, between the rollers.



9. If you are not ready to laminate, press the heater “Cold” button to turn off the heaters

Adjusting Mandrel/Film Tension...

Each type of laminating film has different characteristics and may require laminator adjustment. The tension should be set so that the film moves over the rollers without dimples as the film enters the laminator. Best results are obtained if tension adjustments are made while the unit is at operating temperature. If any adjustments are required use the following procedure:

1. Press the “Run” button.
2. Locate the tension adjustment knob on the top left of the machine near the mandrel. Refer to the diagram on page 6, if you are having trouble locating the knob. Turn the knob to adjust the tension (clockwise to increase, counterclockwise to decrease) until the film passes over the roller without wrinkles and the web between the laminating and pull rollers is tight.



Note: *This adjustment requires only a few degrees of turn. If the knob is turned too far clockwise, you may stall the drive motor.*

3. Repeat for Bottom Supply Mandrel using the tension adjustment knob on the lower right side of the machine near the bottom mandrel.
4. If you are not ready to laminate, press the heater “On/Off” button to turn off heaters and press the stop button to cease roller movement.

LAMINATING

1. Locate the power “On/Off” switch located in the rear of the machine. Flip the switch to the ‘On’ position.
2. Be sure the heaters have been turned on using the heater “On/Off” button and are set at the proper temperature. Be sure the film has been properly threaded.



Do not heat up machine at temperatures higher than 265°F at startup. Once you machine has reached 265°F, a higher temperature can be programmed into the machine.



Do not idle the machine at temperatures higher than 265°F. Overshoot of temperature does occur causing film to burn leading to wrap-arounds. Wrap-arounds are NOT covered under warranty.



Do not allow the temperature to exceed 300°F as this could cause the silicone coating to separate from the roller core on the heated rollers and will void your warranty.

2. Position your document on the feed table such that it enters the machine in the desired position.
3. Press “Run” button to initiate roller movement. The film will begin moving through the laminator.

4. After clear laminating film exits the Pull Rollers at the rear of the machine you may gently guide the first item to be laminated into the laminator.

Note: You may want to run a test lamination first as any item that passes between the rollers will be laminated and cannot be recovered until it exits the rear of the laminator.

5. Additional items may be fed in sequence, keeping enough distance between sheets for trimming.

6. After the last item has exited the Pull Rollers, press the “Stop” button.

7. Use the rear horizontal trimmer to trim items as they exit the laminate. [Use caution as the trimmer contains a sharp blade.]

MOUNTING & LAMINATING

1. Be sure all laminator parts (i.e. safety shield, feed table, etc.) are in their proper positions and the laminating film is loaded correctly.

2. If your machine is not already on, press the “On/Off” button.

3. Set the temperature to no greater than 280°F & Speed #2 to warm up the machine. Once the machine has reached the warm up temperature, the ready lights will illuminate. You can now adjust the temperature according to the film manufacturer’s recommendations for the film you have chosen. The laminator will take approximately 15-20 minutes to reach operating temperature. The set temperature of the heated rollers is indicated on the LED display. When the set temperature is reached, the green LED indicator light will remain illuminated.



Do not heat up machine higher than 280°F at startup for mounting. Once you machine has reached 280°F, a higher temperature can be programmed into the machine.

4. Position the print to be mounted on a section of mount board up to 3/16” thick behind a leader board. The leader board will prevent compression of the leading edge of your mount board.

5. Press the “Run” button to activate roller movement.

6. We recommend using thermal activated mounting boards. If using pressure sensitive boards, peel the release liner from the board back about an inch behind a leader board unless your mount board is larger than your print and you will be trimming your board afterwards. A leader board will prevent compression on the leading edge of your mount board.

7. Feed the print and mount board into the laminator behind the leader board slowly and evenly. **Be sure to pull back the release liner before it enters the rollers.** Allow the machine to remove the release liner as you hold it. If you pull too much liner back the print will become wrinkled onto the board.

8. You may mount subsequent prints now, one directly behind the other so that the board in front becomes the leader board.

9. Once your last print has completely exited the laminator, press the heater “On/Off” button and carefully cut the mounted and laminated prints.

10. If using thermal mount boards set the machines temperature to the manufacturers' specification and decrease speed to allow heat to penetrate your print and activate the adhesive. There will be no liner

Safety Shield...

The safety shield is a safety feature designed to prevent accidental contact with the heated rollers. Rollers can reach in excess of 325°F and are extremely hot. To prevent injury, laminate with the safety shield in the down position.

Auto Shut Off...

The heat mechanism will automatically shut off after two hours of idle time. [If the rollers are not moving, the machine is considered idle.]

TROUBLESHOOTING

The following guide will assist you with most problems that may be encountered when laminating.

PROBLEM: *Laminator is inoperative. Motor does not turn; machine does not heat.*

ACTION: Unit may be unplugged. Connect power supply. Ensure that the circuit breaker has not tripped Fuse may have blown. Replace fuse (rear next to power cord) with 15 amp BUSS (MDA-15) for standard units. **This unit is rated at 15A and should be the only item plugged into a 15A.**

PROBLEM: *Laminator heats, but rollers do not turn.*

ACTION: If pressing the "Run" button does not work, check the motor fuse. You may need to change the fuse. This machine requires a 1A motor fuse.

PROBLEM: *Laminator blows fuses often.*

ACTION: Ensure machine is running on a dedicated circuit. Do not exceed maximum material thickness. Reduce supply mandrel tension.

PROBLEM: *Laminating film and item being laminated move through laminator erratically.*

ACTION: Check thickness of item to be laminated. Maximum thickness is 1/16" (1.6mm). Clean rollers of residual adhesive. Refer to MAINTENANCE section for cleaning instructions.

PROBLEM: *Plastic is not bonding to the item or to itself at the edges.*

ACTION: Make sure rollers are at proper operating temperature and speed and have had time to warm up. For the PRO model, decrease the speed to allow more time for the heated

rollers to reach their set temperature. See Table 1 for the suggested temperature ranges. Ensure you are using quality film. If the temperature is set correctly and the film is not bonding then the film is most likely bad.

PROBLEM: *Wrinkles on laminated item running parallel with supply rolls.*

ACTION: Increase film mandrel tension on top and/or bottom supply rolls; only small amounts between tests. Reduce roller temperature.

PROBLEM: *Stretch lines appear on laminated items running parallel with the outside edges.*

ACTION: Increase supply mandrel tension on top and/or bottom supply rolls. Reduce roller temperature. Clean rollers of residual adhesive. See MAINTENANCE section for cleaning instructions.

PROBLEM: *Blistering of the film appears over the item or along the edge.*

ACTION: Reduce roller temperature. Clean laminating rollers. See MAINTENANCE section for cleaning instructions. There may be moisture in the paper you are laminating. Store paper in a dry place and be sure that any ink is thoroughly dry before laminating.

PROBLEM: *Laminated material curls after leaving pull rollers.*

ACTION: Adjust tension. If laminated item curls upwards, reduce top mandrel tension. If item curls downward, reduce bottom mandrel tension. Clean rollers of residual adhesive as it may be causing “drag” on one side. Refer to MAINTENANCE section for cleaning instructions.

PROBLEM: *Machine smokes and emits fumes.*

ACTION: Reduce temperature. Never exceed 300°F, unplug machine and thoroughly clean rollers.

PROBLEM: *Temperature inaccurate, machine overheating.*

ACTION: Ensure temperature sensor (behind top roller) is in firm contact with roller. See diagram on next page.

MAINTENANCE

This section contains instructions for cleaning and maintaining your laminator. These procedures should be performed at regular intervals to help ensure the trouble-free operation of your laminator.



Before performing any maintenance on your laminator first disconnect the power supply. Hazardous voltages are present when the side panels are removed.

Cleaning the Laminating Rollers...

The Laminating Rollers should be cleaned of any residual adhesive whenever the film does not pass smoothly over their surfaces. Be cautious with sharp objects near the rollers.

1. Allow the rollers to cool.
2. Remove the Feed Table by lifting and pulling it toward you to expose the rollers.
3. Cut the plastic film from the supply rolls and where it exits the rollers. Pull the film toward you and away from the rollers.
4. Lift the film away from the rollers. While holding down the “Rev” button, pull the film forward toward you (from the front of the laminator).
5. Use a soft cloth moistened with denatured alcohol to remove any residue from the surface of the Rollers.
6. Allow the Laminating Rollers to dry before re-threading the film.

Removing Wrap-Arounds...

Wraparounds are the most common issues with laminators. This occurs when film does not clear the rear of the pull rollers; instead, the film gets wrapped around the rollers. They can occur when laminating with thinner gauges of film, when the rollers are not cleaned properly, when the film is threaded improperly and when the laminator is located on a surface that does not allow the film to exit the rear of the machine and “free-fall” to the ground.

Use the same procedure for **Cleaning the Laminating Rollers** in order to remove a wrap-around. You should remove any wrap-arounds that occur as soon as possible. If the film is allowed to cool while wrapped around the rollers it may be more difficult to remove and the heaters may have to be turned on to loosen the film.



The rollers are hot! Use caution when cleaning the rollers or when removing wrap-arounds. Be careful with sharp objects, cutting a rubber roller will ruin it and result in a void of warranty.



NOTE: Ensure that the temperature sensor is touching roller after experiencing a wrap-around. The sensor must be in contact with the roller to accurately sense the roller temperature. Any gap between the sensor and roller will result in a false reading and could result in overheating.

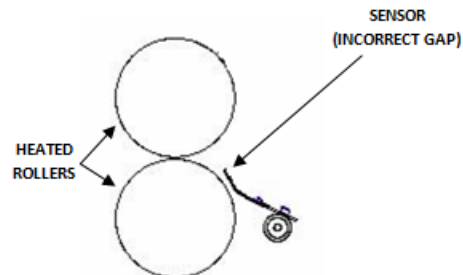
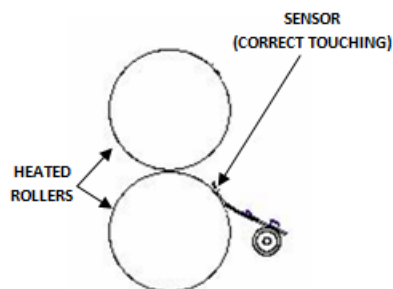

WARRANTY & RETURN POLICY

Warranty...

Your laminator is warranted to be free of defects in material and workmanship for a period of 1 year from the date of original purchase. In the event of a manufacturer's defect in materials or workmanship or for assistance with the operation of a malfunction, please call Martin Yales Tech Support at 800-225-5644 and provide the model number, serial number, dealer purchased from and the date of purchase. Also please attach pictures of the problem and explain in detail the issues you are having, and a technician will get back to you within 24 hours.

Martin Yale, Inc. makes no other warranty stated or implied except as stated above. This warranty does not cover damage to the machine that occurs as a result of misuse, wrap-around or improper handling, or damage to prints. If you receive your machine with shipping damage please contact Martin Yales Customer Service at 800-225-5644. **All freight charges to ship machine back are your responsibility.**

Service Guidelines:

If your laminator is not operating properly, first review the Operating Instructions and the troubleshooting guide. If the malfunction cannot be corrected, contact Martin Yale Tech Support for technical troubleshooting. **Be sure to have your machine serial number and date of purchase handy.**

It will be determined by the technician/manufacturer whether or not the machine is to be sent in to be repaired under warranty. In this case, the customer would be responsible for packaging the machine properly (as any damage during shipping is the responsibility of the customer) and shipping it to the manufacturer. The manufacturer will then repair the machine and would advise you if any additional fees are required due to non-warranty issues and/or return freight. **Please note: Any operator errors resulting in the malfunctioning of the machine are NOT covered under any warranty.**

Return Policy:

If the laminator must be returned to the dealer, there will be a 25% restock fee and it is your responsibility to ensure that it is shipped back in original packaging. Failure to do this will void all warranties. If you do not have the original packaging, please contact your dealer for purchase at an additional charge. **All freight charges to ship machine back are your responsibility.** Shipping damage as a result of improper packaging is not covered under the terms of this warranty.

Martin Yale Industries

251 Wedcor Avenue – Wabash, IN 46992

Phone (260) 563-0641

Email: Info@martinyale.com – Website www.martinyale.com

