

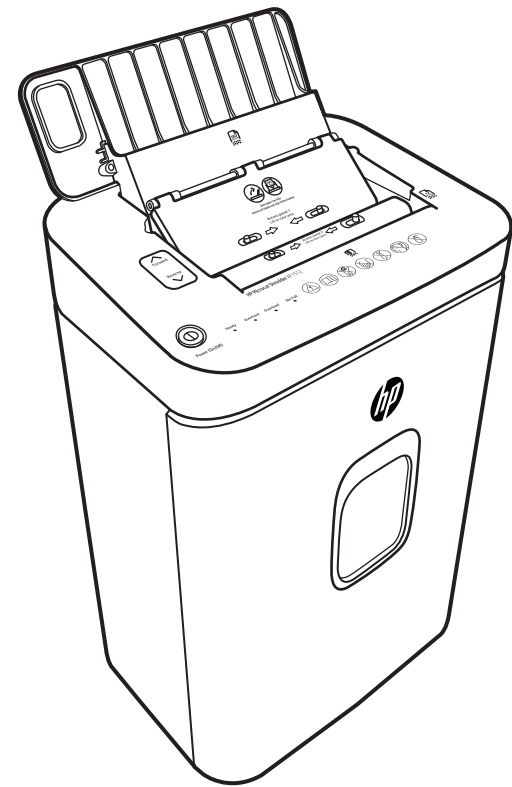

AF1512

Auto Feed
Microcut Paper Shredder

USER MANUAL



ROYAL Consumer Information Products, Inc.
HP Warranty Processing
50 Hilton Street
Easton, PA 18042

www.hp.com/officeequipment

HP is a trademark of HP Inc. or its affiliates, used by Royal
Consumer Information Products under license from HP Inc.

© Copyright, Royal Consumer Information Products, Inc. 2020,
All Rights Reserved.

HP-AF1512IM0521

Made in Vietnam

Please read this manual carefully before use.

Shredder overview

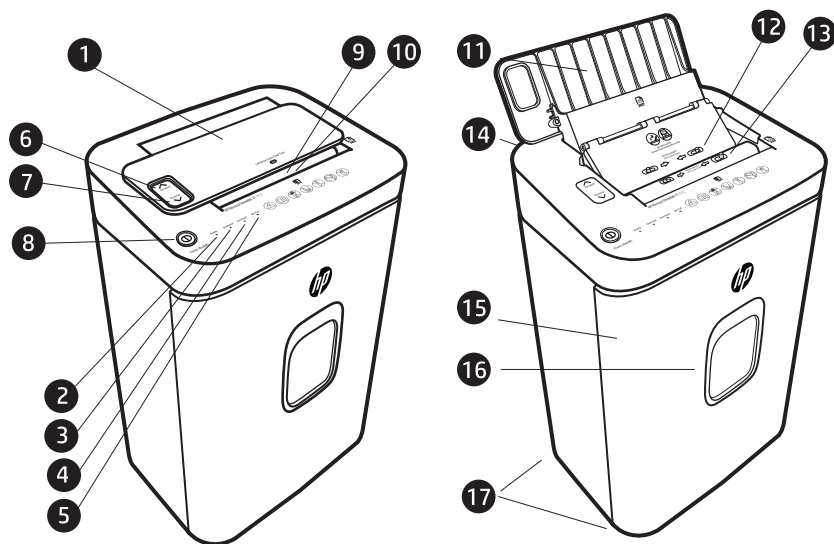

1	Auto feed tray in closed position
2	Ready LED display
3	Overheat LED display
4	Overload LED display
5	Bin full LED display
6	Forward button
7	Reverse button
8	Power On/Off button
9	Manual paper feed entry slot for up to 12 sheets
10	Credit card entry
11	Auto feed tray open to accept up to 150 sheets of paper
12	Locking pins for upper jam access panel
13	Locking pins for lower jam access panel
14	Power cord located in back
15	Pull-out 7.4 gal waste bin
16	Clear window for shred inspection
17	Casters for easy mobility

Limitations/Local laws

EXCEPT AS EXPRESSLY SET FORTH IN THIS LIMITED WARRANTY, THERE ARE NO OTHER WARRANTIES, EXPRESS OR IMPLIED, FOR YOUR HP PRODUCT. ALL OTHER WARRANTIES, INCLUDING ANY IMPLIED WARRANTIES OF MERCHANTABILITY OR FITNESS FOR A PARTICULAR PURPOSE, ARE EXPRESSLY DISCLAIMED. ANY IMPLIED WARRANTIES IMPOSED BY LAW ARE LIMITED IN DURATION TO THE APPLICABLE WARRANTY PERIOD.

This Limited Warranty gives you specific legal rights, and it is governed by the laws of the state and country in which your HP Product was purchased. You may also have other rights that vary from state to state and country to country. You are advised to consult applicable state and country laws to determine your rights. Some states and countries do not allow any limitation on how long a limited warranty will last, or any exclusion or limitation of incidental or consequential damages. In such states and countries, some of the exclusions or limitations stated in this Limited Warranty may not apply to you.

Sole remedies/No incidental or consequential damages

To the extent allowed by local law, the remedies provided in this Limited Warranty are your sole and exclusive remedies. These terms and conditions supersede any prior agreements or representations, including statements made in sales literature or advice given in connection with your purchase.

TO THE EXTENT ALLOWED BY LOCAL LAW, AND EXCEPT AS SPECIFICALLY SET FORTH IN THIS LIMITED WARRANTY, IN NO EVENT SHALL HP, ANY HP SERVICE CENTER OR ANY HP-AUTHORIZED SERVICE PROVIDER BE LIABLE FOR ANY DAMAGES CAUSED BY THE PRODUCT OR THE FAILURE OF THE PRODUCT TO PERFORM, INCLUDING ANY DIRECT, INDIRECT, SPECIAL, INCIDENTAL OR CONSEQUENTIAL DAMAGES, WHETHER BASED ON CONTRACT, TORT, OR ANY OTHER LEGAL THEORY, AND WHETHER OR NOT ADVISED OF THE POSSIBILITY OF SUCH DAMAGES.

Locate your authorized service center

If you need support during the warranty period, locate the Authorized Service Center for this product at:

www.hp.com/officeequipment

Or use the following contact information:

USA: 833-523-0800

Specifications:

Shred type:	Microcut
Shred width:	4.3mm x 12mm
Shredding capacity:	12 Sheets (20 lb. bond paper) or 1 Credit Card
Paper tray capacity:	150 Sheets (20 lb. bond paper)
Duty cycle (auto feed)	30 min on / 40 min off
Feed opening:	8 3/4 inches
Dimensions (W x D x H):	14.8" x 11.02" x 23.07"
Weight:	25.57 lbs. (11.6 Kg)
Input:	115 volt AC, 5.5 Amp, 60Hz

Limited warranty

Your HP Product is warranted to be free from defects in materials or workmanship under normal use for one year, with an additional 4 years on the cutting blades starting on your date of purchase. Your dated sales or delivery receipt is your proof of purchase. You may be required to provide proof of purchase as a condition of receiving warranty service.

During the warranty period, if a defective HP Product covered by this Limited Warranty is returned to the designated Service Center, it will be repaired or replaced or, at the option of the Service Center, its purchase price will be refunded. No repair, replacement or refund will be provided unless the defective HP Product is returned to the Service Center at your expense; for some HP Products, no return will be accepted unless the Service Center first provides you with a Return Material Authorization (RMA). If your HP Product has recurring failures, at the option of the Service Center, either you will be furnished with a different product that is equivalent in performance or you will receive a refund of your purchase price. Service Center support may be provided by an HP subcontractor or other third parties. Please see the Service Center information provided.

Where permitted by local law, HP Products and any replacement products or parts may contain new materials or used materials equivalent to new in performance and reliability. Replacement products or parts will have functionality at least equal to that of the product or part being replaced. Replacement products and parts are warranted to be free from defects in materials or workmanship for 90 days, or for the remainder of the warranty period for the HP Product which they are replacing or in which they are installed, whichever is longer.

This Limited Warranty does not include technical assistance. This Limited Warranty does not cover cosmetic damage, loss or damage in transit, or damage resulting from (a) accident, misuse, abuse or other external causes; (b) product elements not supplied by HP; (c) improper site preparation or maintenance; or (d) modification or service by anyone other than HP, an HP Service Center or another HP-authorized service provider.



Warning

- **ALWAYS** keep out of the reach of children as serious injury could occur.
- **DO NOT** place fingers too close to feed slot as serious injury could occur.
- **AVOID** getting jewelry, hair or loose clothing too close to feed slot as serious injury could occur.
- **ALWAYS** keep shredder off and unplugged when not in use.
- **ALWAYS** unplug shredder when moving, cleaning or emptying the waste receptacle.
- **DO NOT** attempt to feed more sheets of paper than specified on the feeder.
- **DO NOT** attempt to shred materials other than paper, credit cards.
- **ALWAYS** use a power outlet or socket near the shredder so it is easily accessible.
- **ALWAYS** limit continuous shredding to the specified time as suggested in the instruction manual.
- **ALWAYS** empty the waste receptacle prior to the receptacle becoming full.
- **DO NOT** attempt to operate the shredder if it is experiencing any kind of problem.
- **DO NOT** use flammable synthetic oil, petroleum-based or aerosol products of any kind on shredder.
- **DO NOT** touch exposed cutting blades under the shredder head.
- **DO NOT** attempt to repair shredder yourself.



Warning icons:

The Icons, on top of the shredder, warn the user of the potential dangers if the shredder is used improperly.



Warning: Certain actions may cause harmful outcomes



Read user manual completely prior to using shredder



Keep children and pets away from shredder



Keep fingers and hands away from paper shredding opening



Keep loose clothing and dangling items away from paper shredding opening



Keep long hair or accessories away from paper shredding opening



Do not spray aerosol, lubricants or any other accelerant products into this unit

✍ Important information:

A few pieces of shredded paper may be found inside the shredder and the wastebasket. This is normal. All HP shredders are tested at the factory to ensure quality.

Setup:

- The AF1512 shredder should be placed on a flat level surface.
- Make sure that the wastebasket is completely inserted into the shredder cabinet and that it fits flush with the shredder cabinet.
- Plug the power cord into any standard 115-volt AC outlet. We recommend that you do not plug your shredder into the same outlet as other electronic devices.
- After pressing the Power **On/Off** button, the ready **LED** should light up. You are now ready to start shredding.

Operation:

With the electrical cord plugged in, the Power **On/Off** button pressed and the shredder wastebasket properly in place, the Ready **LED** will light up. This means that the shredder is now ready for operation.

It is recommended that when the auto sheet feed is not in use, the Auto feed tray should remain in the closed position.

Manual feed shredding: A maximum of 12 sheets at one pass or a single credit card is recommended. Exceeding the maximum 12 sheet or multiple credit card insertions could result in unnecessary paper jams. When the paper is inserted into the feed opening, the shredding process will start automatically and stop when the paper has completed its travel through the feed opening.

Auto sheet feed shredding: Grasp the front edge of the Auto feed tray and open fully as in Diagram ①. Staples and paper clips should be removed prior to insertion. Place up to 150 sheets of neatly stacked paper into the paper tray as in Diagram ②. The feeding of the paper should begin immediately. The duty cycle for auto feed is 30 min on / 40 min off.

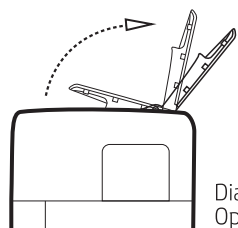

Diagram ①
Open tray fully

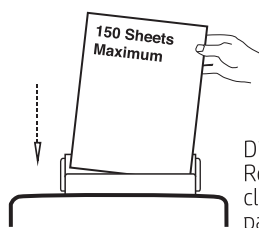

Diagram ②
Remove staples and clips before inserting paper

Electronic features:

- The **Ready LED** lets you know the shredder is working and ready to shred.
- The **Overheat LED** will light up when the motor temperature has reached its maximum allowed temperature and will shut off the power to the motor. When the motor cools down, the shredder will be ready to resume shredding.
- The **Overload LED** will light up when the shredder has exceeded the maximum sheet capacity which is 12 sheets.
- The **Bin full LED** will light up when the waste bin is full and should be emptied.

Sheet capacity:

On manual feed, the AF1512 will shred up to twelve (12) sheets and will accept paper widths up to 8 3/4 inches. When shredding small material like credit cards, envelopes, or receipts, insert them through the middle of the feed opening.

On auto sheet feeding, the AF1512 will shred up to one hundred fifty (150) sheets of paper neatly stacked into the Auto feed tray.

Paper jams in auto sheet feeding:

If during the auto feed function you receive a paper jam, press the reverse button and remove the jam. If the papers have traveled further into the feed rollers and cutters, open Panel 1 by moving both access levers inward and lifting the Panel 1. Open as shown in Diagram ③.

If further access is required to remove the jam, open Panel 2 as shown in Diagram ④, allowing access to the cutter assembly.

Always be very careful when approaching the cutter blades. They are very sharp and could harm you if mishandled. After the jam has been removed be sure Panel 1 and 2 are back in their original secured position.

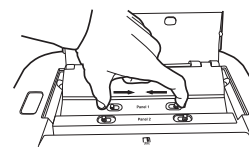

Diagram ③
Open Panel 1.

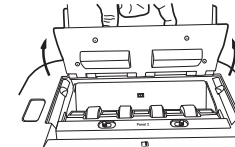

Diagram ④
Open Panel 2.

Minor paper jam in manual sheet feeding:

Press the reverse button and pull the remaining sheets of paper out of the feed opening. Remove the unshredded papers from the top and clear any excess paper shreds from the feed opening. Be careful not to place your fingers near the feed opening or serious harm could result.

Major paper jam in manual sheet feeding:

- Turn off or unplug the power cord from the AC outlet and wait at least 40 minutes for the thermal overload protection to reset.
- Plug in the AC power cord and press the reverse button and grasp the excess paper from the top and pull it out. Be careful not to place your fingers near the feed opening or serious harm could result.