

..puraclenz

P3000

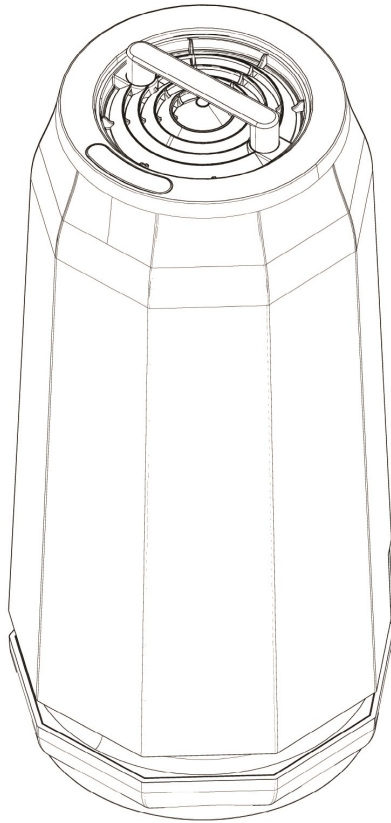

USER GUIDE

QUESTIONS OR FOR MORE INFORMATION

Please visit www.puraclenz.com for instructions, tips and more.

Call our Product Support Line at 1-833-360-PURA

or email us at support@puraclenz.com

READ AND SAVE THESE INSTRUCTIONS

Important Safety Instructions

BEFORE USING THIS MACHINE READ ALL INSTRUCTIONS AND CAUTIONARY MARKINGS IN THIS USER GUIDE AND ON THE MACHINE.

When using an electrical machine, basic precautions should always be followed including the following:
WARNING: These warnings apply to the machine, and also where applicable, to all accessories, lamps, filters or mains adapters.

TO REDUCE THE RISK OF FIRE, ELECTRICAL SHOCK, OR INJURY:

1. This Puraclenz machine is not intended for use by persons (including children) with reduced physical, sensory or reasoning capabilities, or lack of experience and knowledge, unless they have been given supervision or instruction concerning use of the machine by a person responsible for their safety.
2. Ensure machine is fully assembled in line with the instructions before use. Do not dismantle the machine.
3. Do not allow to be used as a toy. Close attention is necessary when used by or near children. Children should be supervised to ensure that they do not play with the machine.
4. Use only as described in this User Guide. Do not carry out any maintenance other than that shown in this manual, or advised by Puraclenz Product Support.
5. Suitable for dry location ONLY. Do not use outdoors and do not expose to water or rain.
6. Do not handle any part of the plug or machine with wet hands.
7. Do not operate any machine with a damaged cord or plug. Discard the machine or return to an authorized service facility for examination and/or repair. If the supply cord is damaged it must be replaced by Puraclenz, its service agent or similarly qualified person in order to avoid a hazard.
8. If the machine is not working as it should, has received a sharp blow, has been dropped, damaged, left outdoors, or dropped into water, do not use and contact the Puraclenz Helpline.
9. Do not stretch the cord or place the cord under strain. Keep cord away from heated surfaces.
10. Do not run cord under carpeting. Do not cover cord with throw rugs, runners or similar coverings. Do not route cord under furniture or appliances. Arrange cord away from traffic area and where it will not be tripped over.
11. Do not unplug by pulling on the cord. To unplug, grasp the plug, not the cord. The use of an extension cord is not recommended.
12. Do not put any object into openings or the inlet grill. Do not use with any opening blocked; keep free of dust, lint, hair, and anything that may reduce airflow.
13. Clean the machine with a wet cloth only. Do not use any cleaning agents or lubricants on this machine. Unplug before cleaning or carrying out any maintenance.
14. Always carry the machine by the base, do not carry it by the top cover handle.
15. Unplug from outlet when not in use for extended periods. To avoid a tripping hazard, safely coil the cord.
16. Do not use near furnaces, fireplaces, stoves or other high temperature heat sources.
17. Do not use in conjunction with or directly next to an air freshener or similar products. Keep essential oils and chemicals away from the appliance.

CAUTION: Changes or modifications not expressly approved by Puraclenz could void the user's authority to operate the equipment. **WARNING:** To reduce the risk of fire or electric shock, do not use this fan with any solid state speed control device.

THIS MACHINE IS INTENDED FOR INDOOR USE ONLY.

NOTE: This equipment has been tested and found to comply with the limits for a Class B digital device, pursuant to Part 15 of the FCC Rules. These limits are designed to provide reasonable protection against harmful interference in a residential installation. This equipment generates, uses and can radiate radio frequency energy and, if not installed and used in accordance with the instructions, may cause harmful interference to radio communications. However, there is no guarantee that interference will not occur in a particular installation. If this equipment does cause harmful interference to radio or television reception, which can be determined by turning the equipment off and on, the user is encouraged to try to correct the interference by one or more of the following measures:

- Reorient or relocate the receiving antenna.
- Increase the separation between the equipment and receiver.
- Connect the equipment into an outlet on a circuit different from that to which the receiver is connected.
- Consult the dealer or an experienced radio/TV technician for help.

This device complies with Part 15 of the FCC Rules. Operation is subject to the following two conditions: (1) this device may not cause harmful interference, and (2) this device must accept any interference received, including interference that may cause undesired operation.

Installation Instructions

For ceiling or wall installations:

1. For drop ceiling installations: Always have a certified electrician perform the installation.
2. If an electrical outlet is not available or cannot be used: Unplug the power cord from the purifier unit and have a certified electrician perform the connection.
3. Pull the power cord connector through the rectangular hole in the mounting bracket. Secure the mounting bracket to the wall or ceiling using the screws positioned in the small ends of the keyholes before tightening the screws. See diagram 3.

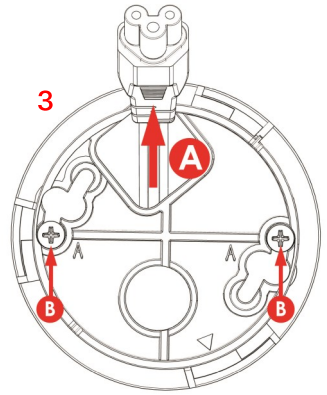

4. Plug in power cord connector into receptacle on bottom of purifier unit. See diagram 4.
5. Install the purifier unit on the mounting bracket and rotate purifier unit in the counter clockwise direction until you hear a click sound. See diagram 5.

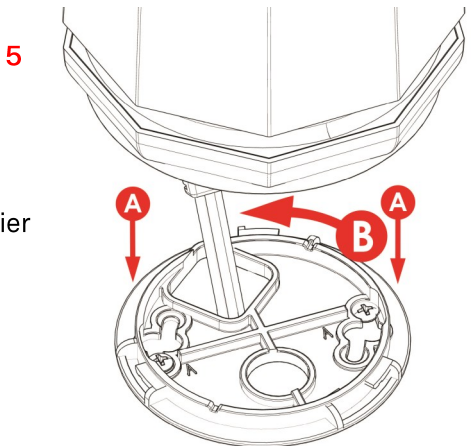
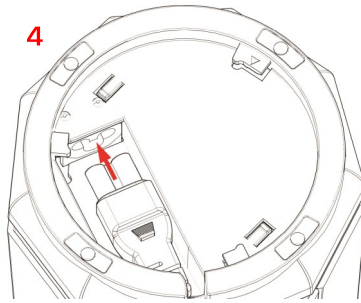

For table top installations:

1. Place purifier unit in desired installation location.
2. Plug into electrical outlet and unit will automatically start purifying.

Display Icons

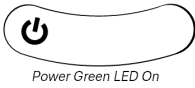

Normal Operation

Power Green LED On

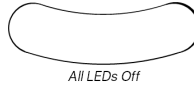

No Power

All LEDs Off

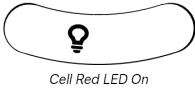

Replace Cell Unit Not Working

Cell Red LED On

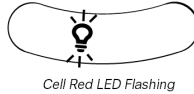

Top Cover Open Unit Not Working

Cell Red LED Flashing



Normal Operation and Order Pre-Filter

Power Green and Pre-Filter Red LEDs On



Pre-Filter Tray Open Unit Not Working

Pre-Filter Red LED Flashing



Change Pre-Filter Unit Not Working

Pre-Filter Red LED On



Call for Service Unit Not Working

Service Red LED On

Maintenance Instructions

Replace Pre-Filter

1. Slide out the old filter and discard.
2. Slide in new Pre-Filter Model#R0001 to automatically resume normal operation.

