

APES-14-77

HD-7700 Version

Operator's Training Manual

Issue "A1" 09/03
P/N 900599

Performance Design Inc.
2350 East Braniff St.
Boise Idaho 83716

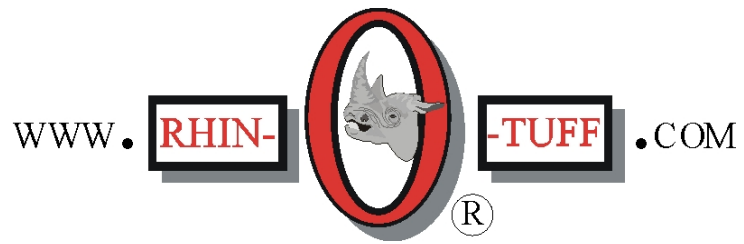

**This manual contains very important safety information
and must be read!**

APES-14-77 Operators Training Manual

Issue “A1” 09/03

The APES-14-77 will greatly increase productivity. An in-depth look at the set up procedures necessary to achieve maximum results follows.

The APES-14-77 is an attachment for the HD-7700 P. D. I. punch. This manual discusses all of the necessary steps to transform the punch into an Automatic Paper Ejecting and Stacking (A. P. E. S.) punch machine. The paper specifications for punching, ejecting, and stacking are between 14” x 14” (maximum) down to 8-1/2” x 5-1/2” A5 (minimum). It will also punch mixed stock including tabs and acetate cover material.

Please see the HD-7700 Manual for die setup and machine use.

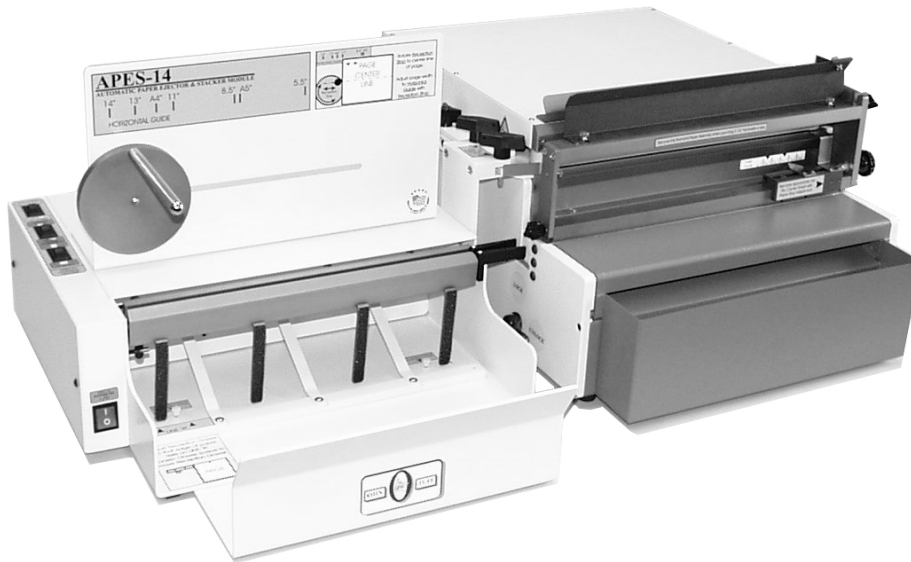

APES-14-77 with an HD-7000 Punch

Table of Contents

Chapter / Topic:	Page Number:
1) Important safety notice!	3
2) Placing the APES-14-77 in the proper location.	3
3) Preparing your HD-7700 for the APES-14-77.	4
4) Right Die Clamp Handle Replacement.	5
5) Mounting the APES-14-77 to a HD-7700 punch.	8
6) Plugging in the APES-14-77 for the first time.	11
7) Operating the APES-14-77.	12
1. Control Center and Power Overview.	12
2. Reception Setup.	13
3. Accessing the Die with an HD-7700.	13
4. Ejector Setup 6" and larger paper.	14
5. Ejector Setup 5-1/2" and smaller paper.	16
6. Ready to Operate.	17
8) Troubleshooting Guide.	18
9) HD-7700 Removing Punch Pins.	19
10) Electrical Diagram for APES-14-77.	20

Tools required; 12" ruler, light hammer, masking tape.

1) Important Safety Notice!



Make sure you read this section very carefully! Learn to recognize this **Safety Alert Symbol**. The APES-14-77 & electric punch has been designed to provide a very high level of protection to an operator. Follow the guidelines below while installing, operating and maintaining your machine.



- If the machine cycles erratically, call dealer immediately for service.



- Never bypass Safety devices.



- Turn both power switches off before removing a die or performing maintenance.

2) Placing the APES-14-77 in the proper location:

Locate a clear work area 48" wide X 30" deep with a duplex outlet within 5 feet that provides a 15-amp service (16-amp European) which is protected at the customer's circuit box. The work area must be a solid and firm cabinet or a heavy duty table with a flat level surface. **Never attempt to move the HD punch with one person! Always move your HD punch with two people, one on each side.** Locate your HD-7700 on the right side of a 48" wide work area with the chip tray near the front edge of the work area.

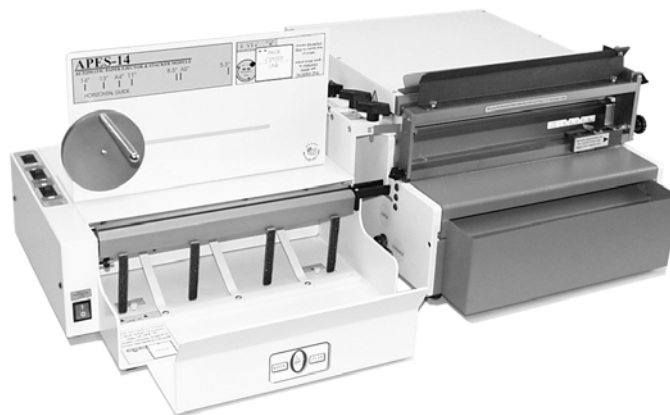

(HD-7000 Shown)

3) Preparing your HD-7700 for the APES-14-77:



- **Unplug HD-7700 from outlet! DO NOT OPEN COVER!! Hazardous voltage inside! Crush hazard! Keep hands away from moving parts!**
- Unplug foot pedal and store (the APES-14-77 has a foot pedal). See Figure B.
- If you have a Palm Switch attached to your HD-7700, unplug, detach and store.
- See Figure B and Un-tighten completely #1-Knob and remove #2-Paper Pointer Guide from #3-Adjustable Mounting Block. Store these Items.

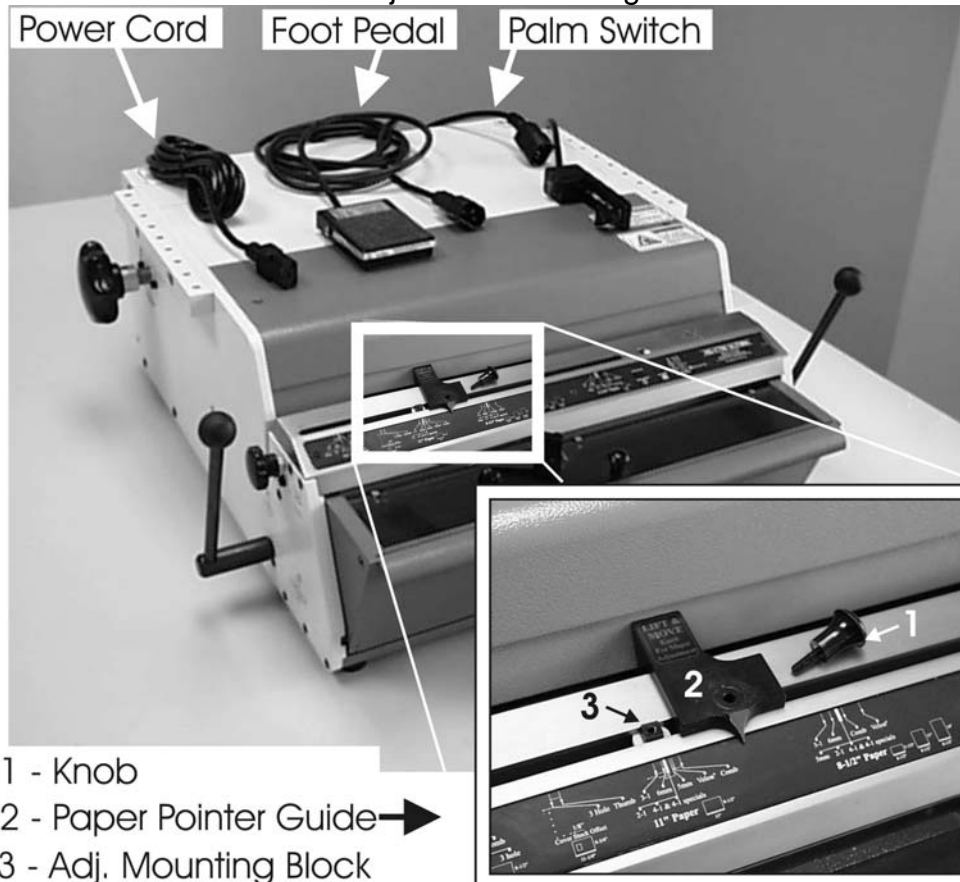

Fig. B

- Your APES-14-77 came with two required Interface Blocks (Figure C page 5) that are 9" long by 3/4" Square, and four 1/4-20 X 1-1/4" socket head cap screws, and an Allen wrench for securing the APES-14-77 to the HD-7700. You will fasten them to the sides of the HD-7700 punch next.
- On each side of the HD-7700 locate the **top most and two forward most Allen screws** and remove them using the short side of the Allen wrench for leverage and turning counter clockwise see Figure "C" (page 5) for location.
- Orient an Interface Block with the **oval hole forward** as shown in figure C (page 5), and **round hole to the rear** of the HD machine over the two available holes. Make sure the **counter bores** in the blocks face outward. See the counter bore example in Figure D (page 5). Note the *nine other mounting holes* will face up and down. Screw in the longer supplied socket heads just a few turns with your fingers.

- **Tighten the rear Allen screws first** using the short side of the Allen wrench turning clockwise then the second Allen screw, attach the block securely to the side of the machine as shown in Figure B and C. Repeat on other side of HD-7700.

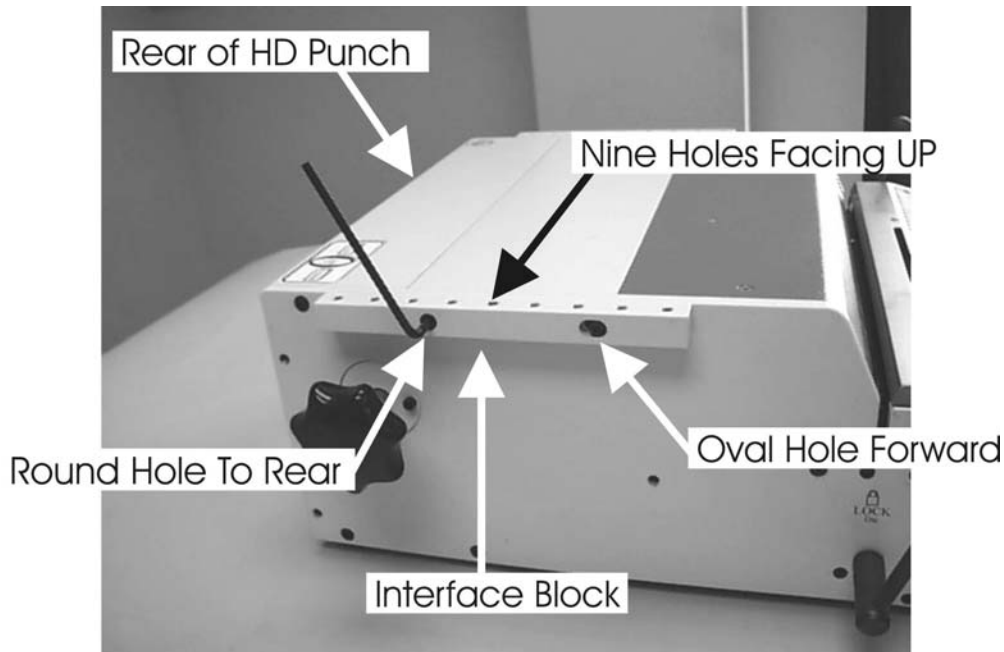

Fig. C
Oval Hole Forward On Block

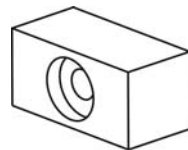

Fig D
Counter Bore Example

CHAPTER 4

4) Right Die Clamp Handle Replacement; A series of HD-7700 were built without the long extended right die clamp handle. It is recommended you replace the short die clamp handle to avoid being pinched while changing dies with the APES-14-77 mounted on your HD-7700. It should only take a few minutes to replace the handle if required.

- **Determine If Your HD-7700 Requires Handle Replacement;** Use a ruler and measure the length of the right die clamp handle extension. See Figure E, if your die handle extension measures 3" from the right side of the machine skip to chapter 5, your HD-7700 came equipped with the longer die clamp handle. If your extension is around 2" or less please complete this chapter and replace your die clamp handle.

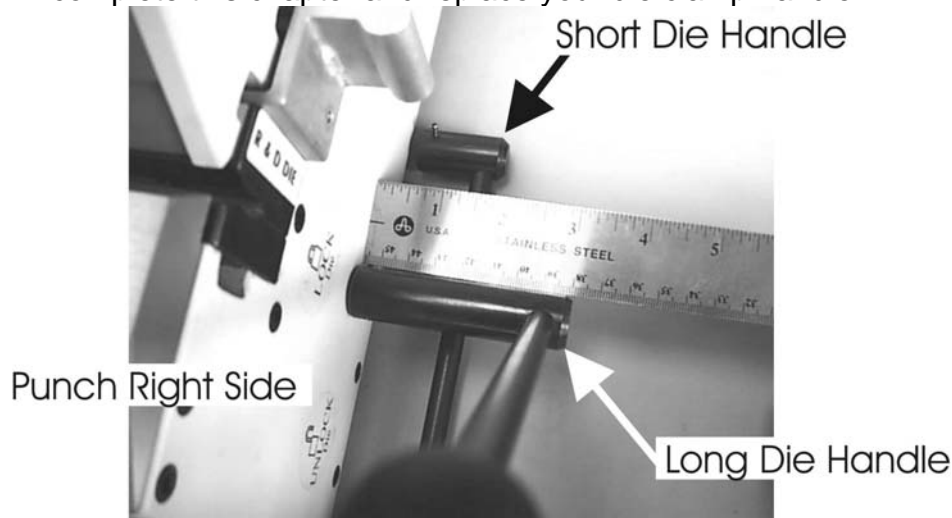
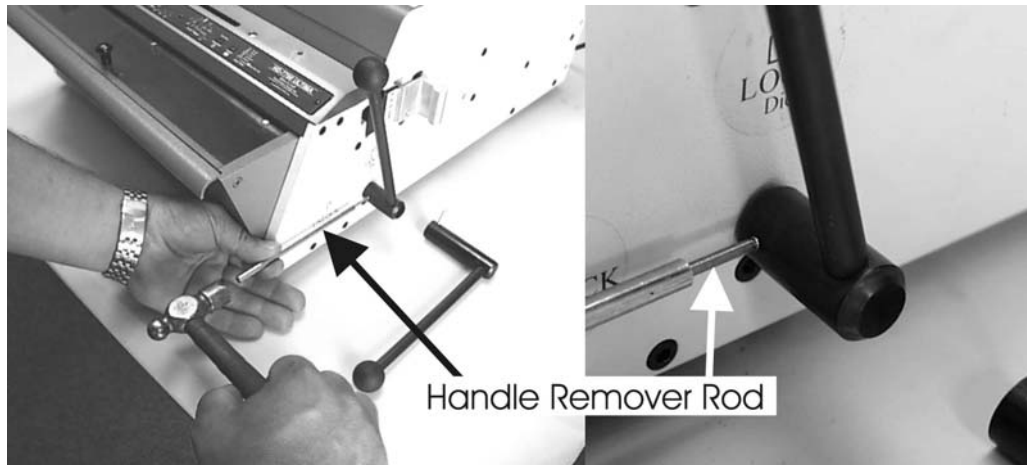

Fig E

- Your APES-14-77 came with a P/N 000664 SPUD ADAPTER KIT. Follow these instructions to replace the handle;
 1. Insert any die into the HD-7700.
 2. **Lock** both HD-7700 Die Handles.
 3. Using the **Handle Remover Rod** that came in your kit and your hammer, see the following image, gently drive out the handle mounting pin from the front of the handle. Drive the pin completely out, remove the **Handle Remover Rod**, and twist clockwise (so you don't unlock the die), the short handle off from the right side of the HD-7700. Discard handle.



4. In a twisting motion, press on the new longer handle assembly. Reuse the **Handle Remover Rod** and insert it into the front side of the handle as shown in the next image. Twist clockwise and push the handle until the Handle Remover Rod falls into and aligns both

the new long handle mounting hole and the HD-7700 machine handle rod hole as shown. The new handle came with a pin partially set into the back side. Do not push this out.

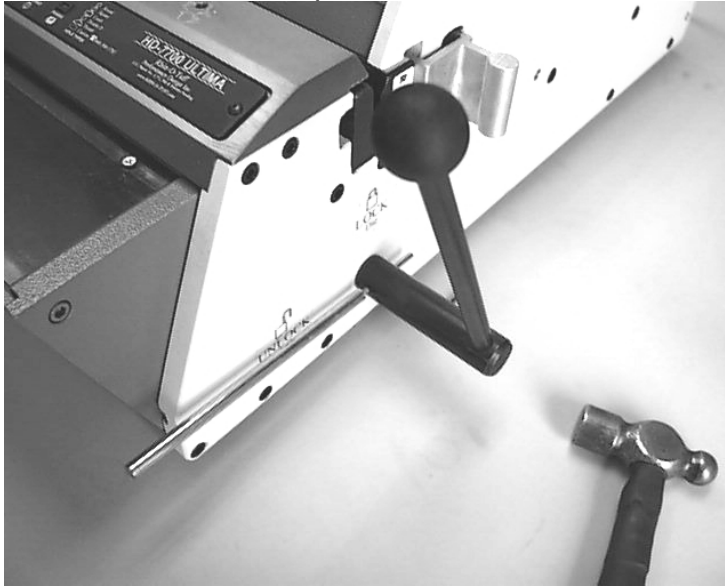

5. Use a piece of masking tape or duct tape and place it on the side of the machine near the pin so as not to scratch your HD-7700 during pin replacement. Using your hammer, gently drive the new pin fully into the back of the new handle assembly until flush. This will push the **Handle Remover Rod** out. Discard the old pin and Handle Remover Rod.



6. The long die clamping handle replacement is complete.



Completed Die Clamping Handle With Flushed Pin

CHAPTER 5

5) Mounting the APES-14-77 to a HD-7700 punch.

- Place the APES-14-77 Ejector Top Plate Assembly on top of the HD punch. **Avoid colliding the APES-14-77 Front Paper Guides and the Drive Motor Assembly into the HD punch while setting the APES-14-77 down.** Keep control cable clear. See Figure F.

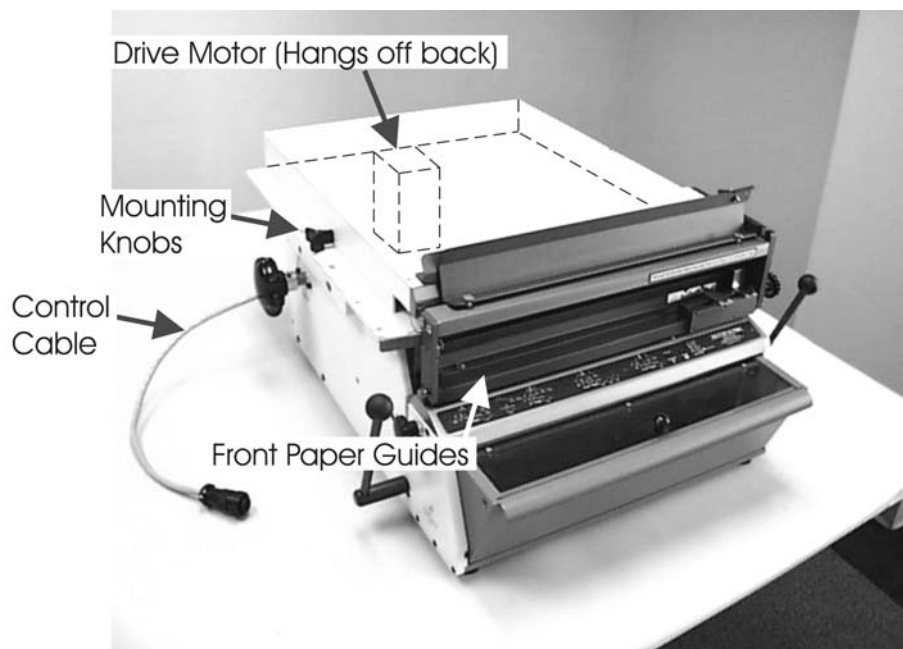

Fig. F
Ejector Top Plate Assembly on an HD-7700 punch

- Push the APES-14-77 Ejector Base Plate Assembly **lightly** back against the front of the HD-7700 punch.
- **Notice the *Rear Paper Guide*** on each side of the machine in Figure F1;

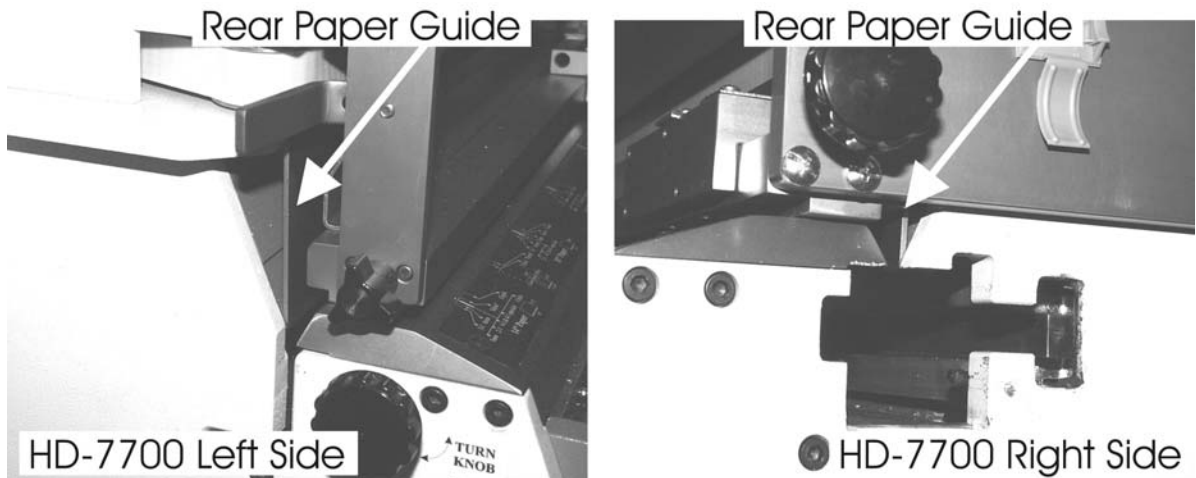

Fig F1

The Rear Paper Guide will fit exactly between both HD-7700 side plates and rest against the front of the HD-7700 top front cover. Locate the APES-14-77 into this position without bending the Rear Paper Guide forward.

- Install and tighten the two 3-winged *mounting knobs* provided into the last (rear) mounting slots. See Figure F (page 8).
- Move the APES-14-77 Reception Assembly next to the HD punch. See Figure G. Note that the *Reception Pivot Block* will align centered about the *Ejector Top Plate Reception Mounting Bar* as shown. See Figure G1.

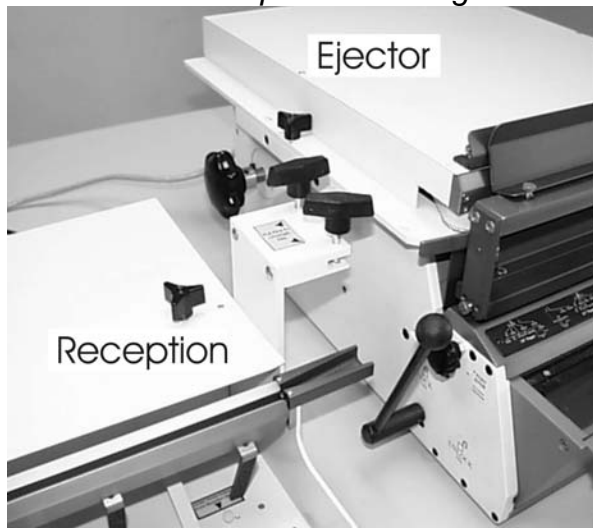

Fig. G

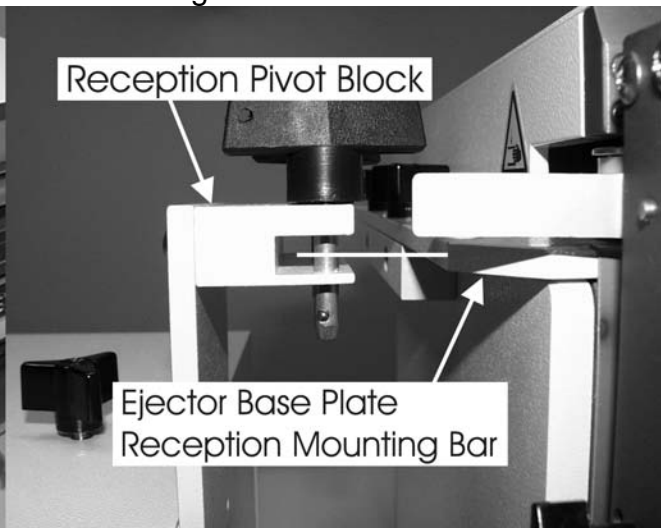

Fig. G1

Move the APES-14-77 Reception next to the HD punch

- These alignments were made during manufacturing, but if the reception fails to align with the Ejector Top Plate you will need to adjust the Reception Pivot Block with two *adjustment screws* at the base of the *Pivot Block Mount* just under the lid on the inside of the Reception. See Figure H (page 10).

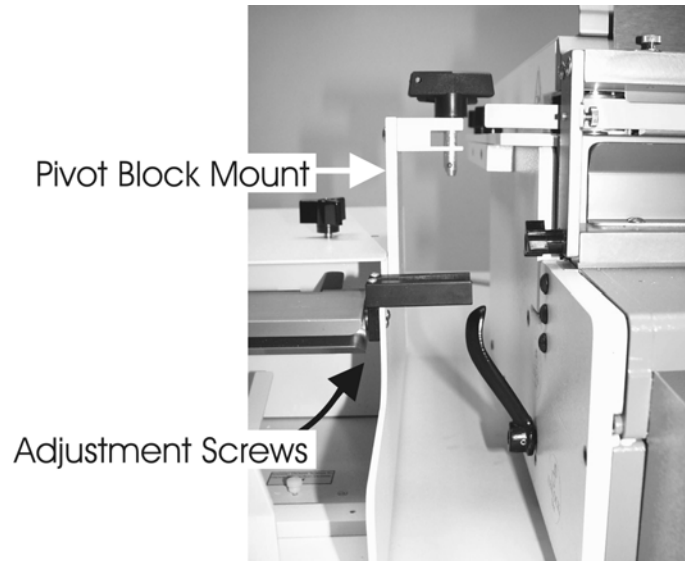

Fig. H

- Mount the APES-14-77 reception to the APES-14-77 Ejector Base Plate with the two supplied large 2-winged mounting **push pins** thru assembly holes in both the reception and Ejector Plate.
- Mount the *Reception Paper Stop* to the *Reception Paper Guide*. See Figure I.

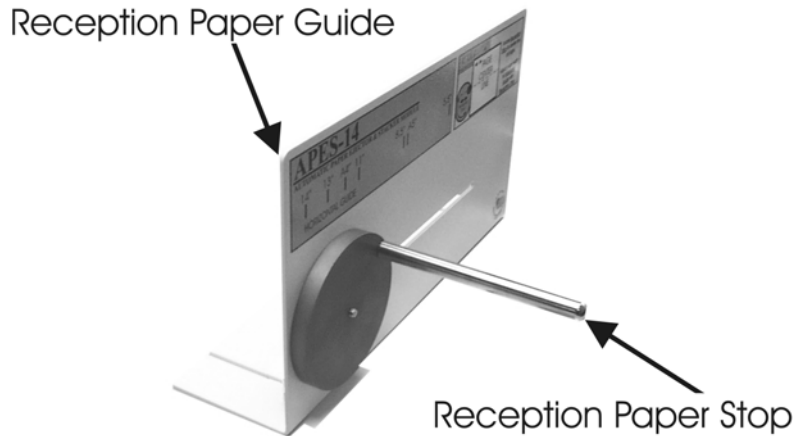

Fig. I

- Mount the *Reception Paper Guide* to the APES-14-77 Reception top with 2 supplied *3-winged knobs*. Push the assembly to its back-most position. This is the standard location for the Paper Guide. The Paper Stop adjustment is covered later in this manual. See Figure J (page 11).

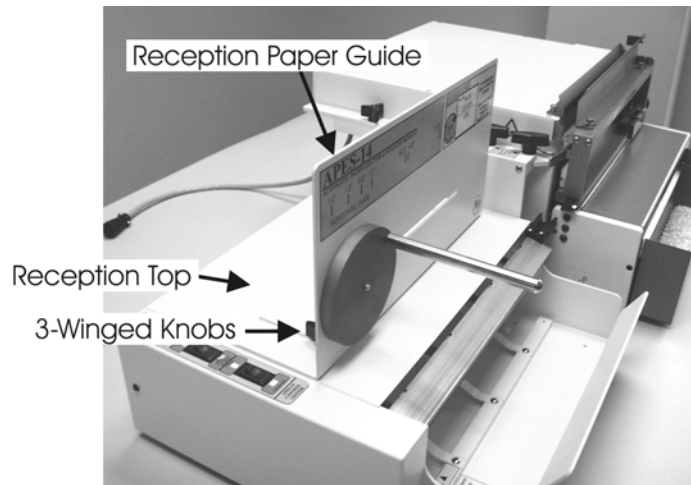

Fig. J
Reception Paper Guide and Paper Stop

CHAPTER 5

6) Plugging in the APES-14-77 for the first time:

See Figure K. Attach the Reception cable to the back of the HD-7700 punch. Attach the APES-14-77 multi-pin Control Cable from the Ejector Assembly to the back of the Reception Assembly by inserting the keyed connector and tightening the collar. Attach Both AC cables and plug into the protected AC duplex outlet.

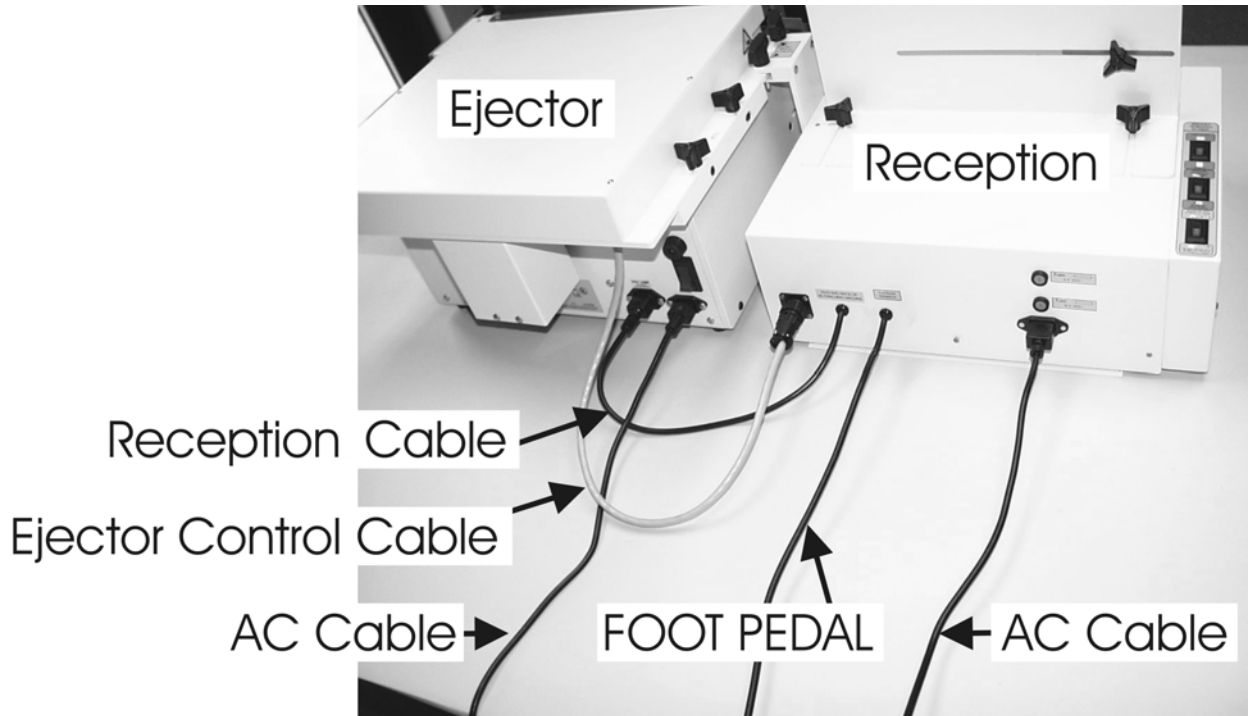
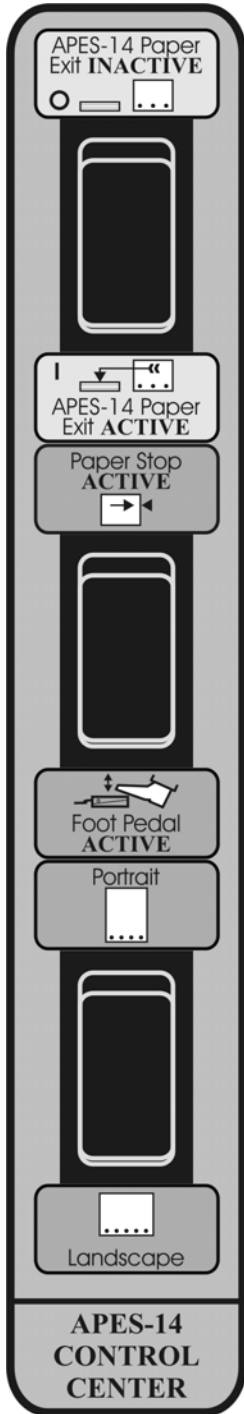

Fig. K
Full Plug Layout

7) Operating the APES-14-77.

1. Control Center and Power Overview;



APES-14-77 Paper Exit INACTIVE – Switching to this position puts the APES-14-77 in idle status. Your HD punch will still operate normally but the APES-14-77 will not eject and stack.

- Normal setting for this switch is down.

APES-14-77 Paper Exit ACTIVE – Puts the APES-14-77 in the active status. Your HD punch and APES-14-77 will work together punching, ejecting, and stacking.

Paper Stop ACTIVE – When selected, the Paper Stop overrides the foot pedal. By pushing the paper against this switch, it positions the paper in the correct location so the holes are centered in the sheet and also activates the punch. (See assembly instructions within the Paper Stop package)

- Normal setting for this switch is down.

Foot Pedal ACTIVE – When selected, it allows for normal punch activation with the foot pedal. Both the foot pedal and Paper Stop Switch can be installed, this allows switching between them. Only one is active at a time.

Portrait – Changes APES-14-77 machine timing to better accommodate stacking portrait paper.

- Normal setting for this switch is down.

Landscape – Changes APES-14-77 machine timing to better accommodate stacking landscape paper.

APES-14-77 POWER ON I/O – Turns the APES-14-77 off. It is recommended you turn the APES-14-77 off when you're done for the day. The HD punch has its own independent power switch that should be powered off also. On 230VAC machines, this is only an indicator and the power switch is on the back side of the APES-14-77.

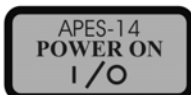

2. Reception setup:

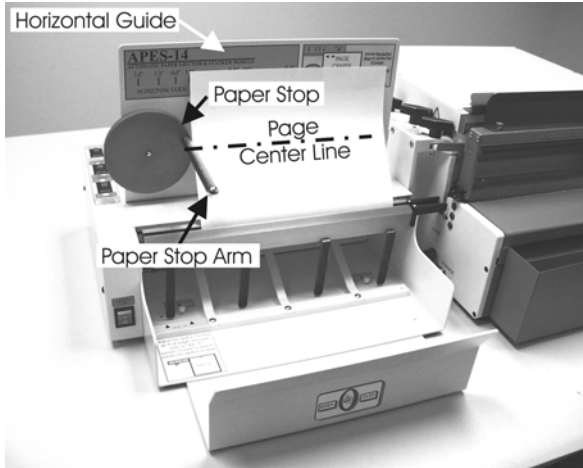

Fig. Q

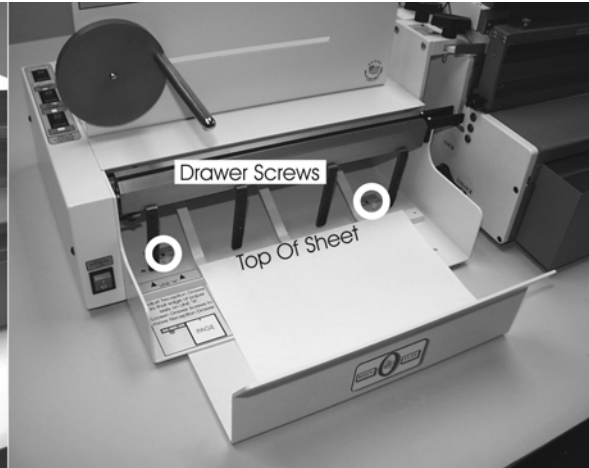

Fig. R

Loosen *Paper Stop* (shown in Figure Q) then turn and move so that the *Paper Stop Arm* is aligned with center of page and width of page value matches the mark on the horizontal guide, tighten *Paper Stop*. Loosen *Drawer Screws* (see Figure R) and pull out reception drawer until sheet's top edge aligns with LINE "A" yellow label and bar edge (see graphics inside drawer). Lightly tighten screws.

3. Accessing the Die with a HD-7700 machine.

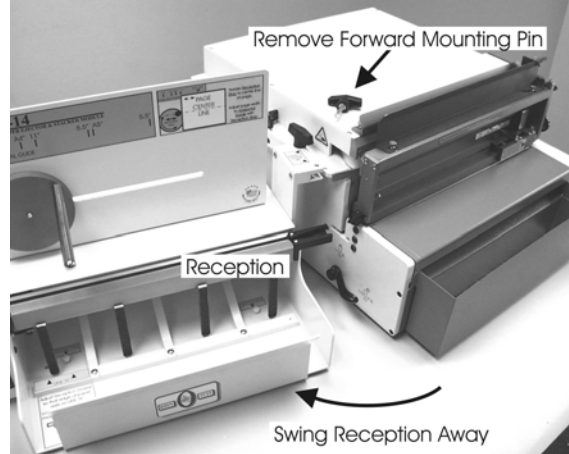

Fig. S



Turn both power switches off before removing a die or performing maintenance. See Figure S. To change the die on a HD-7700, pull the forward APES-14-77 Reception mounting pin and pivot the Reception away from the HD-7700. This will allow access to the left HD-7700 die locking handle. Unlock both handles, replace die, lock both handles, then swing the APES-14-77 Reception back in place and replace forward mounting pin. If the die locking handles are loose enough, swinging the APES-14-77 may not be necessary.

4. Ejector Setup 6" and larger paper.

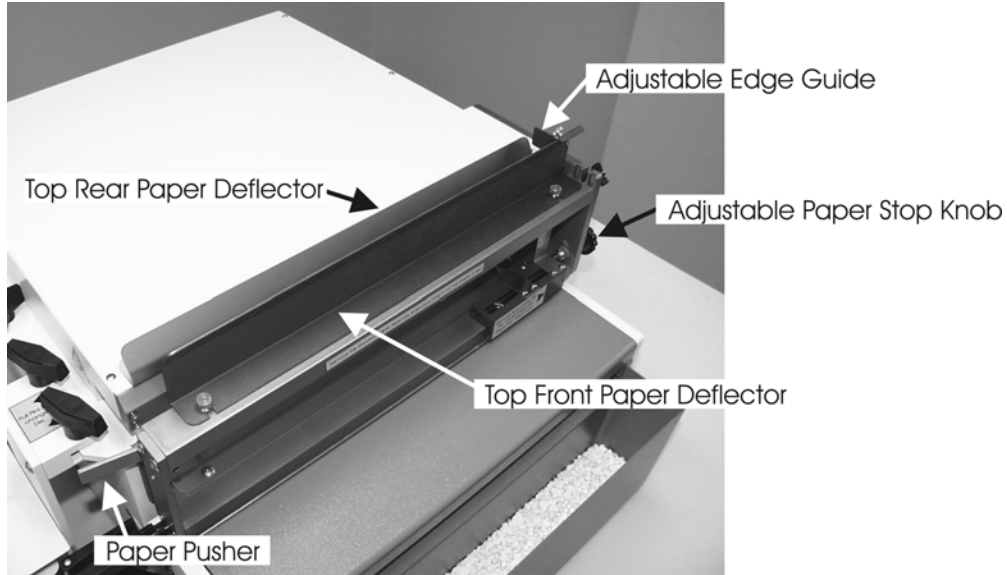

Fig. T

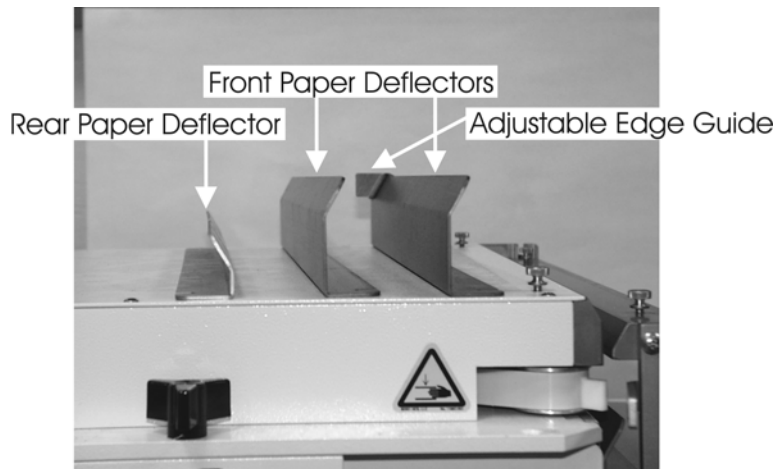

Fig. U

Your APES-14-77 came without the Paper Deflectors installed. The machine came with a large *Top Front Paper Deflector* with an *Adjustable Edge Guide* attached to it and a large *Top Front Paper Deflector* without an Edge Guide, see Figure U. Also included is a small *Top Rear Paper Deflector*, see Figure U. This section will cover when to use each Deflector and how to adjust the *Paper Pusher* and *Adjustable Paper Stop Knob*, see Figure T.

- **Adjustable Paper Stop Knob:** This adjustment knob is used to center the pins (holes) within your sheet. Please see the HD-7700 Manual for die setup and machine use or see Section 9 on page 18 in this manual. Move the Adjustable Edge Guide to the most right position so it will not conflict with the Paper Stop while adjusting.

- **Adjustable Edge Guide:** After setting up the Paper Stop, place a sheet in the APES-14-77 Ejector against the Paper Stop, then move the Adjustable Edge Guide against the page and tighten the screw. This guide is primarily used while punching Portrait documents to better stabilize the top of the sheet against the Paper Stop. However it can be used on Landscape documents also if the user finds it more comfortable.
- **Top Rear (and Front) Paper Deflectors:** These guides make paper insertion into the APES-14-77 and HD punch easier and quicker. Some operators may prefer reversing guide positions or simply removing the Top Rear Deflector for better ease. These next three images illustrate the suggested deflector setups;



Fig. V

This image shows the large Top Front Paper Deflector with the Adjustable Edge Guide in the forward configuration. This configuration is best suited for landscape 8 ½" x 11" paper.

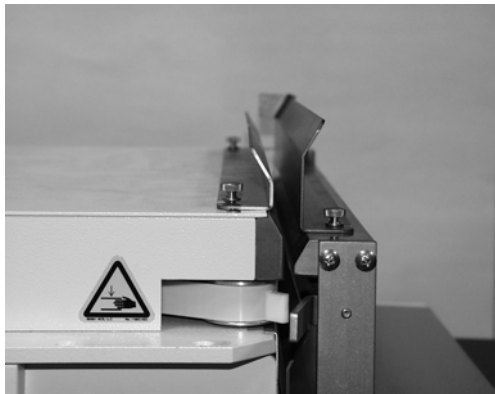

Fig. W

This image shows Figure V along with the small Top Rear Paper Deflector installed. This configuration is preferred for portrait 8 ½" X 11" paper.

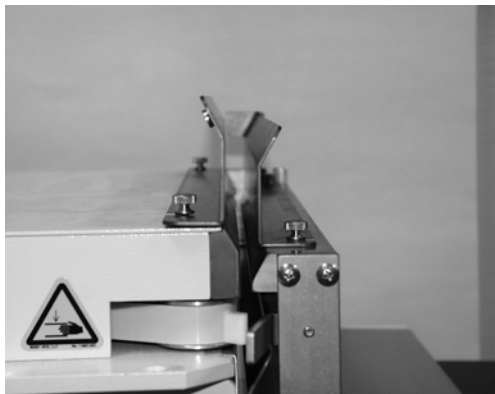

Fig. X

This image shows Figure W, but with the second large Rear Paper Deflector replacing the small Rear Paper Deflector. This configuration can be used with portrait 8 ½" X 11 paper to gain extra support. With most larger paper size jobs, you may prefer this configuration.

➤ **Paper Pusher:**

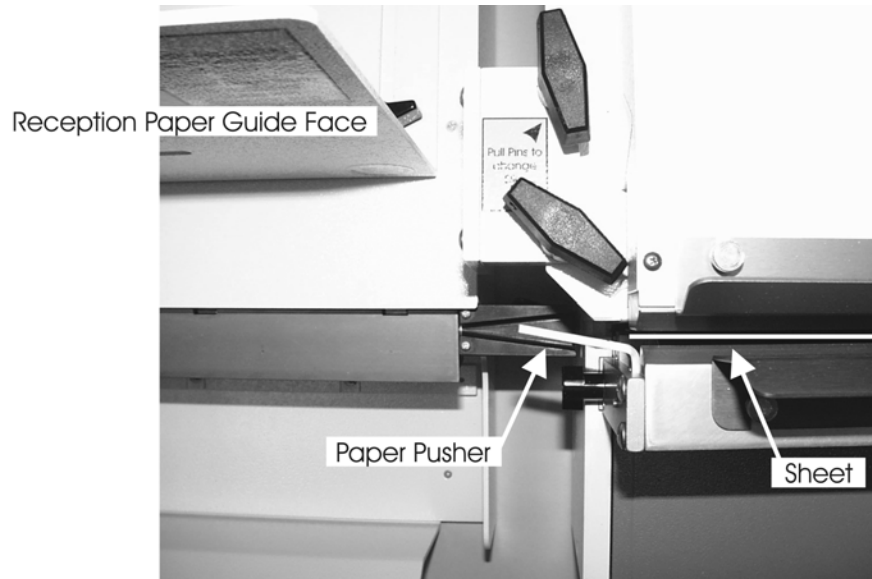

Fig. Y

See Figure Y. This guide was pre-setup. But if it requires re-setup, this is the intended use: When the Ejector releases a sheet(s), the Paper Pusher should *slightly* divert the sheet(s) toward the Reception Paper Guide face. This action allows the Reception Paper Pivot to better stack paper. The Paper Pusher is necessary on all jobs but it is most important for Portrait jobs.

4. Ejector Setup 5-1/2" and Smaller Paper.

Sheets that stand 6" tall may use either Ejector setups. Sheets shorter than 6" must remove the Bracket Assembly to access the sheets within APES-14-77;



Fig. Z

Remove the Bracket Assembly by loosening the two thumb screws located one on each end of the assembly as shown and shift assembly left so that the Assembly falls clear of the Ejector. After removing the assembly, re-tighten the screws.

5. Ready to Operate the APES-14-77.

Now that you have setup both the APES-14-77 Reception and Ejector you're ready to begin a job.

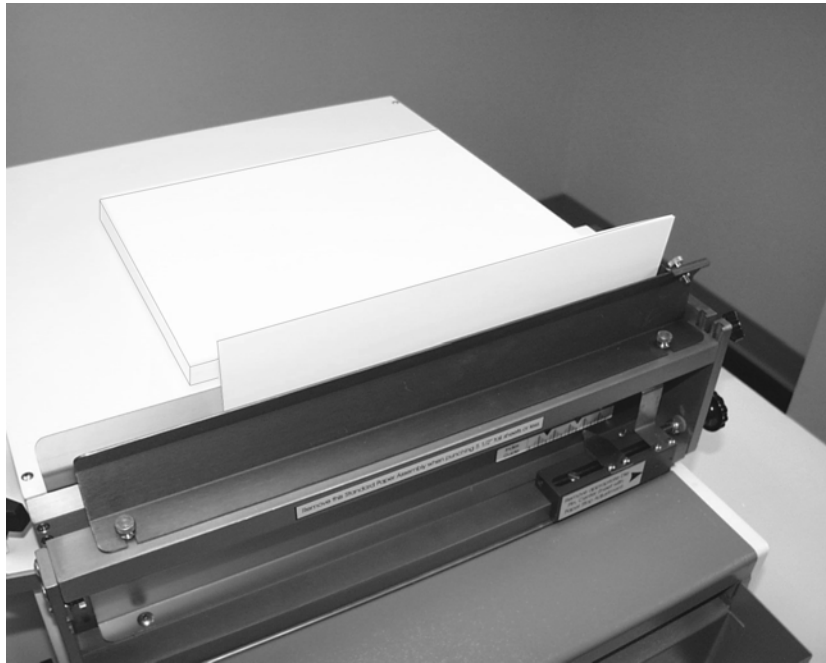

Fig. AA

Place your job on top of the Ejector just behind the punching location. Locate the edge to be punched toward the front of the machine and face up. Position your Foot Pedal in a comfortable location.

Begin loading the APES-14-77 Ejector by picking 20-25 sheets and setting them in the APES-14-77 Ejector down inside the HD punch die, and jogging the pages down and right against the Paper Stop(s). As you actuate the foot pedal begin reaching for another 20-25 sheets to feed into the Ejector. Repeat.

You will find the APES-14-77 has increased your productivity by doing the take-away and stacking of your job for you.

8) Troubleshooting Guide;



Only qualified personnel should attempt to work on this equipment.

The APES-14-77 is a well-built, heavy duty Auto Paper Ejector Stacker system and will give years of reliable service. Most of the problems are due to setup error. There are two fuses located on the rear of the reception tray. Below is a troubleshooting guide to help you through some of the problems that may be encountered.

Symptom	Possible Cause	Action
APES machine does not cycle. Paper pivot and ejection belt do not move. (HD Punch does not cycle)	<ol style="list-style-type: none"> 1) APES section not turned on. 2) APES not plugged into wall socket. 3) Foot pedal or paper stop switch not plugged into machine. 4) APES in paper stop switch mode without option attached. 5) Blown fuse or fuses. (A: Amber indicator light is off. Located in switch on front panel.) (B: Amber indicator is on) 	<ol style="list-style-type: none"> 1) Check power switch. 2) Check both ends of power cord. 3) Make sure foot pedal or paper stop switch cable is attached to machine. 4) Make sure APES is set to foot pedal mode when no paper stop switch is attached. 5) (A: Check fuse 1 if amber indicator light is off) (B: Check fuse 2 if amber indicator light is on)
Apes machine cycles. Paper pivot and ejection belt move but HD punch does not operate.	<ol style="list-style-type: none"> 1) HD punch not turned on. 2) HD punch not plugged into wall socket. 3) Apes not plugged into HD punch. 4) Die not locked in position. 5) HD punch not operating. 	<ol style="list-style-type: none"> 1) Check power switch. 2) Plug both ends of power cord. 3) Plug APES into foot pedal receptacle on back of HD punch. 4) Make sure both die handles are up and locked on HD punch. 5) Plug original foot pedal back into HD punch. Go through troubleshooting procedure using HD punch manual.
Paper pivot moves and HD punch operates. (ejection belt does not move on APES section)	<ol style="list-style-type: none"> 1) Grey cable is unplugged from back of reception. 	<ol style="list-style-type: none"> 1) Make sure grey cable is plugged into back of reception.
APES ejection belt moves but paper pivot does not.	<ol style="list-style-type: none"> 1) O-ring belt needs adjustment. 2) Belt needs replacement. 	<ol style="list-style-type: none"> 1) Motor can be adjusted to tighten belt. 2) Replace belt by sliding off of both pulleys. (to gain access to motor adjustment and belt replacement, remove two screws from switch and belt cover)
Ejection belt runs continuously.	<ol style="list-style-type: none"> 1) Check micro switch under top cover. 	<ol style="list-style-type: none"> 1) Adjust or replace.
Ejection belt stop at random positions.	<ol style="list-style-type: none"> 2) Check micro switch under top cover. 	<ol style="list-style-type: none"> 2) Adjust or replace.

9) HD-7700 Removing Punch Pins:

Make sure the machine is turned off before removing the die. To remove a punch pin from the die, disengage both quick change die handles and slide the die to the right until the die is completely removed from punch.

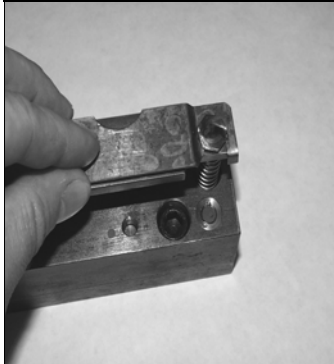

Step 1. Remove top pin retainer by pushing down first, and then pulling away from bottom pin retainer to expose punch pins.

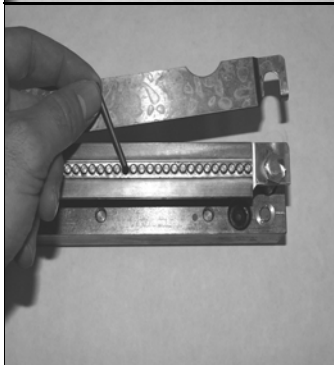

Step 2. Remove desired punch pin.

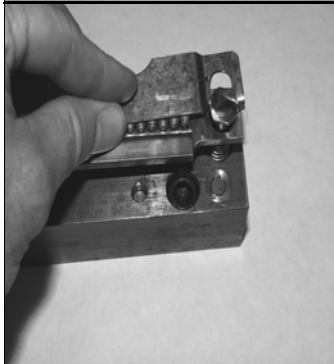

Step 3. Place edge of top pin retainer along punch pins and press down while pulling pin retainer back to original position.



Step 4. Install die into machine as described in previous section.

10) Electrical Diagram for APES-14-77.;

