

Horizon

Paper Folder PF-40L

PF-40L

Paper Folder

**Handles wide range of paper stock
with suction rotor feeding.**



 **spiral**

800.631.3572

SpiralBinding.com

High Quality in a Compact Body!

High performance suction rotor feeding and accurate sheet registration leads to high quality folding.

A4 (8.5" x 11") finish letter fold*1 can be folded in the compact body.

*1: Only letter fold is available when using the sheet which length is 630 mm (24.80").

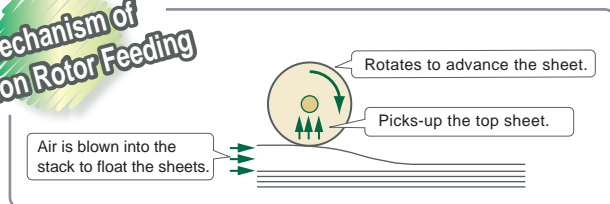

Photo: PF-40L + MT-40L (Optional Table)

High Performance Suction Rotor Feeding

Uniquely designed suction rotor feeding is employed to meet high speed production up to 390 sheets per minute, wide range of paper stock can be fed with ease.

Mechanism of Suction Rotor Feeding



Quick and Easy Setup

Simply select sheet size and fold pattern and each section sets-up automatically. The folder is equipped with 2 buckles to meet a variety of folds. Fine-tune adjustment can be done at 0.1 mm for accurate folding.

Folding Patterns

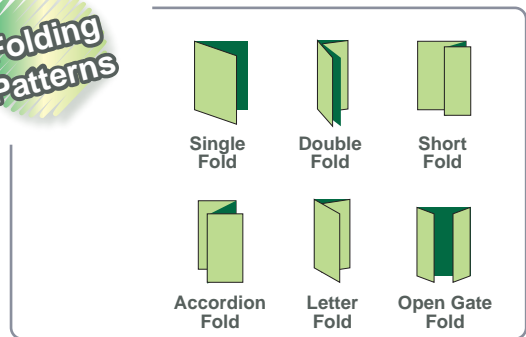

Simple Operation Panel

User friendly operator console for easy operation and setting. Programming such as pre-set counting and job memory can be set-up for efficient production.



Job memory

Up to 20 jobs can be stored in memory for instant recall, this is especially useful for repeat and complicated jobs.

Air volume adjustment

Air volume adjustment can be done to feed a wide range of paper stock from 52.3 gsm to 157 gsm.

Speed adjustment

Selective speed mode is arranged for 5 steps such as high speed mode at 390 sheets per minute and quiet mode for an office environment.

High Capacity Feeder

High capacity feed table (1,300 sheets of 64 gsm can be loaded) to minimize sheet loading during longer production runs.



Crisp Tight Fold Quality

Crisp tight fold quality is ensured with uniquely designed combination of soft polyurethane foam rubber and steel rollers. Roller gap can be adjusted with a simple dial to fold thinner to thicker sheets.



Accurate Sheet Registration

Registration guide ensures accurate sheet transportation and a high quality fold.

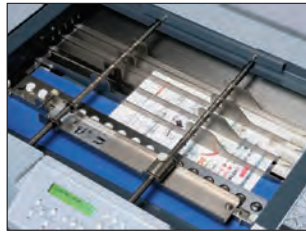

High Capacity Delivery Conveyor

Folded sheets are neatly stacked on the delivery conveyor for easy job handling. Up to 1,000 sheets can be stacked for efficient production.

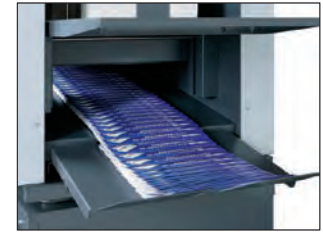

Photo: PF-40L + MT-40L (Optional Table)

Easy Maintenance

Sheet jam removal and roller cleaning is quick and easy with the unique maintenance feature.



Simple Operation Steps

Simply place sheets on the table, then select sheet size and desired fold pattern.



1 Place sheets.



2 Select sheet size and fold pattern.



3 Press the start button.

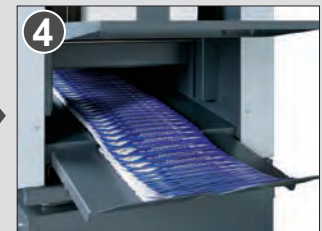

4 Finish.

PF-40L Major Specifications

Sheet Size	Max. 320(W) x 630(L) mm (12.59" x 24.80") (For a sheet longer than 470 mm, only the fold patterns within the stopper setting range are possible.) Min. 125(W) x 128(L) mm (4.93" x 5.04")
Matrix Size	A3, A4, B4, B5 (11" x 17", 8.5" x 14", 8.5" x 11", 5.5" x 8.5")
Sheet Weight Range	Normal Paper 52.3 to 157 gsm
Maximum Pile Height	Max. 105 mm (4.13") (Ex. 1,300 sheets 64 gsm)
Fold Patterns	Single Fold, Double Parallel Fold, Short Fold, Accordion Fold, Letter Fold, Open Gate Fold
Production Speed	270 sheets/min. (A3 Single Fold) 390 sheets/min. (A4 Single Fold) Total Counter (Up to 9,999)
Other Function	Preset Counter (Up to 9,999) Preset Pause Counter
Voltage / Frequency	Single Phase 115 V, 50 / 60 Hz Single Phase 230 V, 50 / 60 Hz
Power Consumption	115 V, 50 / 60 Hz, 520 W 230 V, 50 / 60 Hz, 500 W
Machine Dimensions	Main Body : 1,560(W) x 630(D) x 770(H) mm (61.5" x 24.8" x 30.4") Pedestal with Wheel : 1,154(W) x 533(D) x 530(H) mm (45.5" x 21.0" x 20.9")
Machine Weight	Main Body : 135 kg (297.7 lb) Pedestal with Wheel : 28 kg (61.8 lb)

Machine Dimensions Unit : mm (inch)

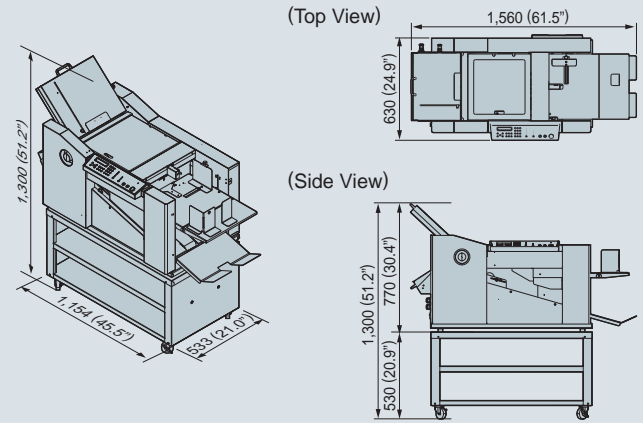

*The machine design and specifications are subject to change without any notice.

A wide range of folders are available

PF-39 : Tabletop Folder

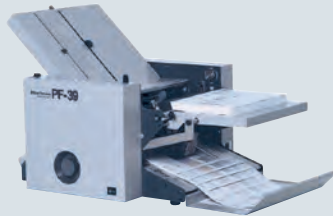

PF-40L : Suction Rotor Feeding Paper Folder



AF-406T6A : Suction Rotor Feeding Buckle Folder



Major Specifications

	PF-39	PF-40L	AF-406T6A
Feeding Mechanism	Friction Feeding	Suction Rotor Feeding	Suction Rotor Feeding
Sheet Size (Width x Length)	Max. 365 x 610 mm (14.37" x 24.01") Min. 90 x 128 mm (3.55" x 5.04")	Max. 320 x 630 mm (12.59" x 24.80") Min. 125 x 128 mm (4.93" x 5.04")	Max. 400 x 650 mm (15.74" x 25.59") Min. 50 x 100 mm (1.97" x 3.94")
Sheet Weight Range	Normal Paper 52.3 to 157 gsm	Normal Paper 52.3 to 157 gsm	Normal Paper 35 to 157 gsm
Maximum Pile Height	Max. 30 mm (1.18")	Max. 105 mm (4.13")	Max. 500 mm (19.6")
Production Speed	A4 (8.5" x 11") - Single Fold, 350 sheets/min.	A4 (8.5" x 11") - Single Fold, 390 sheets/min.	A4 (8.5" x 11") - Single Fold, 500 sheets/min.
Folding Stopper Position Adjustment	Manually adjusted by LED indication for folding position	Automated	Automated